



**Hilti X-BT
Threaded Fastener
Specification**

**Supplement
02/2012**

**X-BT threaded
fasteners for use in
nuclear power plants**

**February 2012,
revised August 2012**

Content

1	Introduction and scope of supplement	2
2	Technical data for NQA-1-2000 compliant X-BT fasteners	3
2.1	General statement	3
2.2	Fastening tool and components	4
2.3	Load data	5
2.4	Connection types and application range	6
2.5	Grounding and bonding restrictions	7
3	Literature	7

1. Introduction and scope of supplement

The specification of the Hilti X-BT threaded fastener is published in the brochure *Hilti X-BT Threaded Fastener Specification*, issue December 2010 [1] and a supplement dated November 2011 [2].

The specification contains

- Application description
- Technical data
- Method statement
- Description of technical performance
- Approval survey
- Customer testimonials

This supplement deals with the X-BT threaded fasteners, which are covered by the ANSI/ASME NQA-1-2000 nuclear quality standard [3].

Figure 1 gives an overview of the respective NQA-1-2000 compliant X-BT fasteners including their special item numbers. It also shows the extension adapter X-SEA-R 30 M8. As these item numbers differ from the item numbers listed in [1] and [2], it is required to establish a clear link of the NQA-1-2000 compliant items with the technical data given in [1] and [2]. This link is provided by this supplement.

The most relevant technical data is also summarized in this supplement.

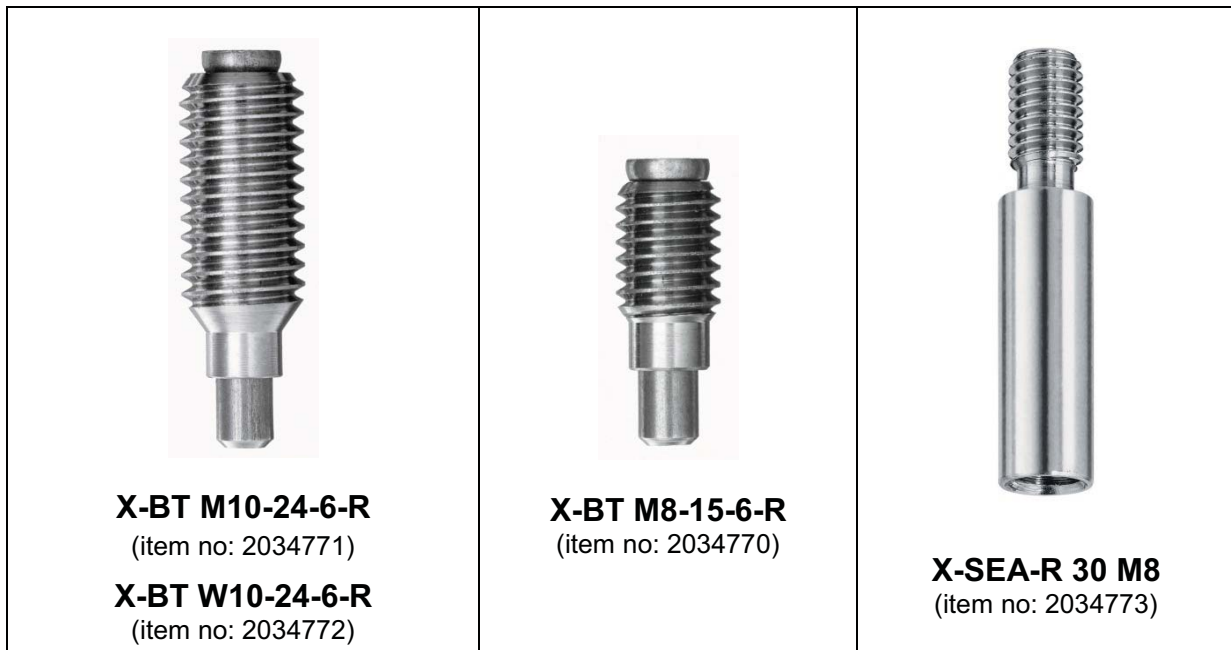


Figure 1. Survey of Hilti X-BT and X-SEA fasteners to be covered by ANSI/ASME NQA-1-2000 quality standard [3]

In general this supplement needs to be read in conjunction with the *Hilti X-BT Threaded Fastener Specification*, issue December 2010 [1].

With respect to further details on the fasteners, method statement, cartridge recommendation, use of powder-actuated tools, and quality control it is referenced to the provisions in [1].

2. Technical data for NQA-1-2000 compliant X-BT fasteners

2.1 General statement

Table 1 gives an allocation of the NQA-1-2000 compliant items and those items listed in the X-BT Threaded Fastener Specification [1]. The geometry and the materials of the threaded sleeve are identical. The material of the shank of the NQA-1-2000 compliant fasteners is CR500 or 1.4462 (X2CrNiMoN22-5-3) according to [1].

Therefore, the technical data given in [1] applies also to the NQA-1 compliant items.

Table 1. Relevant X-BT fasteners

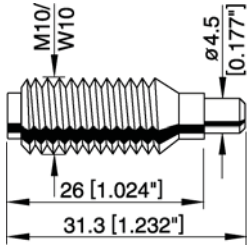
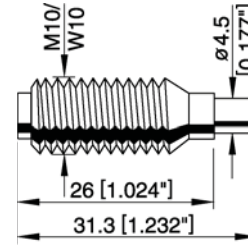
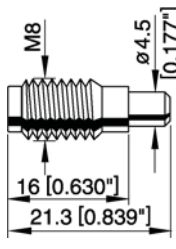
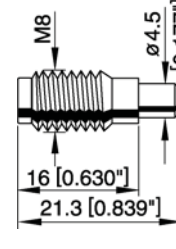
NQA-1-2000 compliant fastener	Respective fastener covered in [1]
<p>X-BT M10-24-6-R (item no: 2034771)</p> <p>X-BT W10-24-6-R (item no: 2034772)</p> 	<p>X-BT M10-24-6-R (item no: 377077)</p> <p>X-BT W10-24-6-R (item no: 377075)</p> 
<p>X-BT M8-15-6-R (item no: 2034770)</p> 	<p>X-BT M8-15-6-R (item no: 377073)</p> 

Figure 2 shows the geometry of the X-SEA-R 30 M8 extension adapter.

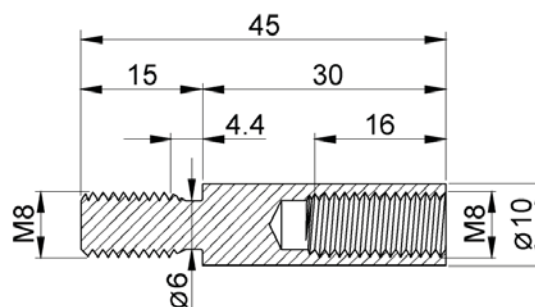


Figure 2. Section of X-SEA-R 30 M8 extension adapter

2.2 Fastening tool and components

The following Table 2 provides an allocation between the threaded fasteners and the respective X-BT system components.

Table 2. X-BT fasteners and respective system components

Fastener	Fastening tool and components	Cartridge	Step shank drill
X-BT M10-24-6-R (item no: 2034771)	Tool: DX 351 BT Fastener guide: X-351-BT FG M1024 (item no: 378674) Piston: X-351-BT P 1024 (item no: 378676)	6.8/11 M brown High Precision (item no: 377204)	TX-BT 4/7-80 (item no: 377079)
X-BT W10-24-6-R (item no: 2034772)	Tool: DX 351 BT Fastener guide: X-351-BT FG W1024 (item no: 378673) Piston: X-351-BT P 1024 (item no: 378676)		TX-BT 4/7-110 (item no: 377080)
X-BT M8-15-6-R (item no: 2034770)	Tool: DX 351 BTG Fastener guide: X-351-BT FG G (item no: 378675) Piston: X-351-BT P G (item no: 361211)		TX-BT 4/7-150 (item no: 377081)

For optimized drilling performance the use of the cordless Hilti drilling tool XBT 4000-A is recommended.

The three step shank drills only differ in their length. Their optimized use depends on the accessibility condition on the jobsite.

The recommended tool energy setting = 1. If required, energy setting needs to be increased based on job site tests. The required fastener stand-off h_{NVS} needs to be met.

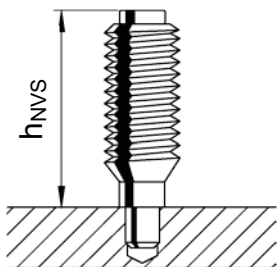


Figure 3.
Fastener stand-off

Compared with [1], the fastener stand-off range remains unchanged as follows:

- $h_{NVS} = 15.7 - 16.8$ mm for X-BT M8
- $h_{NVS} = 25.7 - 26.8$ mm for X-BT M10/W10

2.3 Load data

Section 3.2 of [1] applies. Table 3 repeats the recommended working loads for the X-BT fasteners driven into unalloyed carbon steel [1].

Table 3. Recommended loads for X-BT fasteners driven into unalloyed carbon steel

Loading direction	Recommended loads dependent on ultimate base material strength R_m	
	$360 \text{ N/mm}^2 \leq R_m < 450 \text{ N/mm}^2$	$450 \text{ N/mm}^2 \leq R_m \leq 720 \text{ N/mm}^2$
Tension	$N_{rec} = 1.8 \text{ kN (405 lbs)}$	$N_{rec} = 2.3 \text{ kN (517 lbs)}$
Shear	$V_{rec} = 2.6 \text{ kN (584 lbs)}$	$V_{rec} = 3.4 \text{ kN (764 lbs)}$
Bending	$M_{rec} = 8.2 \text{ Nm (6 ftlb)}$	$M_{rec} = 8.2 \text{ Nm (6 ftlb)}$

Installation torque $T_{rec} = 8 \text{ Nm (5.9 ftlb)}$.

The installation torque applies for new, non-lubricated A4- or AISI-316 nuts, new coated A4- or AISI-316 nuts or new A4- or AISI-316 lock-nuts combined with appropriate washers made from A4- or AISI-316 material.

Conditions for the recommended loads:

- Base material: Unalloyed structural steel with a minimum ultimate tensile strength R_m of 360 or 450 N/mm², respectively. 360 N/mm² covers e.g. S235 according to EN 10025-2 and 450 N/mm² covers e.g. S355 according to EN 10025-2, Grade S460 according to EN 10025-4 or Grade 50 according to ASTM A572.
- Pre-dominantly static loading
- Global factor of safety for static resistance: ≥ 3 (based on 5% fractile), ≥ 5 (based on mean value)
- Minimum edge distance = 6 mm (1/4")
- Redundancy (multiple fastening) must be provided

Table 4 shows the recommended interaction formula in case of combined loading:

Table 4. Recommended interaction formula

Combined loading situation	Interaction formula
V – N (shear and tension)	$\frac{V}{V_{rec}} + \frac{N}{N_{rec}} \leq 1.2$ with $\frac{V}{V_{rec}} \leq 1.0$ and $\frac{N}{N_{rec}} \leq 1.0$
V – M (shear and bending)	$\frac{V}{V_{rec}} + \frac{M}{M_{rec}} \leq 1.2$ with $\frac{V}{V_{rec}} \leq 1.0$ and $\frac{M}{M_{rec}} \leq 1.0$
N – M (tension and bending)	$\frac{N}{N_{rec}} + \frac{M}{M_{rec}} \leq 1.0$
V – N – M (shear, tension and bending)	$\frac{V}{V_{rec}} + \frac{N}{N_{rec}} + \frac{M}{M_{rec}} \leq 1.0$

V, N and M correspond with the maximum working loads (see internal forces in Figure 4) acting on the fastener shank in the section of the top surface of the base steel.

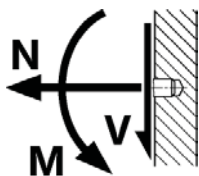


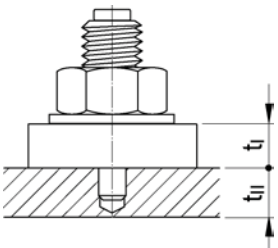
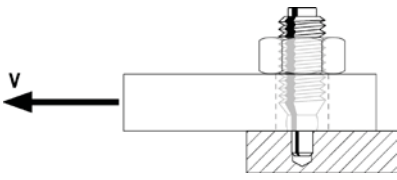
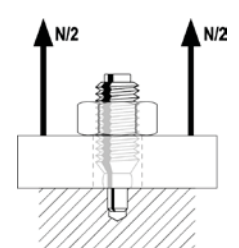
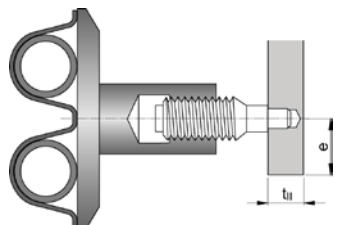
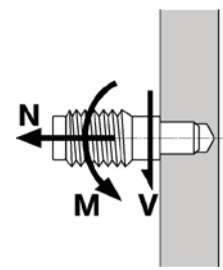
Figure 4.

Internal forces

2.4 Connection types and application range

Table 5 summarizes the possible types of connection, the corresponding loading and the respective range of application.

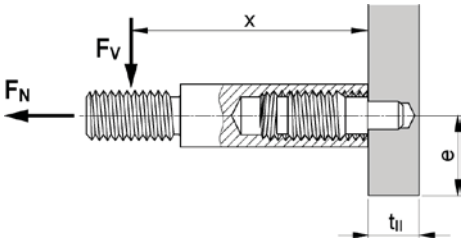
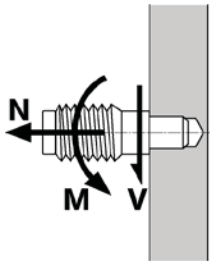
Table 5. Types of connection and corresponding loading conditions, range of application

Type of connection	Type of loading	Range of application
<p>Connections of steel sheets or plates to steel base material</p> 	<p>Lateral shear loading</p> 	<p><u>Covered fasteners:</u></p> <ul style="list-style-type: none"> ▪ X-BT M10-24-6-R ▪ X-BT W10-24-6-R <p><u>Fastened material (component I):</u> Structural carbon steel or corrosion resistant steel according to EN 10025, EN 10346 and EN 10088-2 with:</p> <ul style="list-style-type: none"> ▪ $R_m \geq 330 \text{ N/mm}^2$ ▪ thickness $10 \text{ mm} \leq t_1 \leq 15 \text{ mm}$ <p><u>base material (component II):</u> Unalloyed carbon steel (uncoated):</p> <ul style="list-style-type: none"> ▪ $R_m \geq 360 \text{ N/mm}^2$ ▪ $t_{II} \geq 8 \text{ mm}$ ▪ Minimum edge distance: $e \geq 6 \text{ mm}$ ▪ Surface: Mill scale without corrosion protection ^{*)}
	<p>Tensile loading</p> 	
Type of connection	Type of loading	Range of application
<p>Connection of installation devices to steel base material</p> 	<p>Shear, tension and bending loading</p> 	<p><u>Covered fasteners:</u></p> <ul style="list-style-type: none"> ▪ X-BT M8-15-6-R ▪ X-BT M10-24-6-R ▪ X-BT W10-24-6-R <p><u>Base material (component II):</u> Unalloyed carbon steel</p> <ul style="list-style-type: none"> ▪ $R_m \geq 360 \text{ N/mm}^2$ ▪ $t_{II} \geq 8 \text{ mm}$ ▪ Minimum edge distance: $e \geq 6 \text{ mm}$ ▪ Surface: Mill scale without corrosion protection ^{*)}

^{*)} The use of the fasteners on corrosion protected steel with a coating thickness $\leq 0.5 \text{ mm}$ is possible, provided the corrosion protection of the base steel is repaired at the entrance location of the fastener with appropriate measures.

Table 6 shows the type of connection for the fastener X-BT M8-15-6-R in connection with the X-SEA-R 30 M8 extension adapter.

Table 6. Type of connection: X-BT with X-SEA-R 30 M8 extension adapter

Type of connection	Type of loading	Range of application
<p>Stand-off installation</p>  <p>The bottom of extension adapter needs to be in contact with the base material.</p>	<p>Shear, tension and bending loading</p> 	<p><u>Covered fasteners:</u></p> <ul style="list-style-type: none"> ▪ X-BT M8-15-6-R <p><u>Base material (component II):</u> Unalloyed carbon steel</p> <ul style="list-style-type: none"> ▪ $R_m \geq 360 \text{ N/mm}^2$ ▪ $t_{II} \geq 8 \text{ mm}$ ▪ Minimum edge distance: $e \geq 15 \text{ mm}$ ▪ Surface: Mill scale without corrosion protection ^{*)}

^{*)} The use of the fasteners on corrosion protected steel with a coating thickness $\leq 0.5 \text{ mm}$ is possible, provided the corrosion protection of the base steel is repaired at the entrance location of the fastener with appropriate measures.

Detailing and design of the fixed component is out of scope of this document.

Structural check of the X-BT has to be made with the internal forces N , V and M acting on the shank at the top surface of the base metal (Figure 4). These are calculated as follows:

$$N = F_N$$

$$V = F_V$$

$$M = F_V \cdot x$$

with:

- N , V , M ... maximum working loads (internal forces N , V and bending moment M)
- F_N ... Axial component of the resulting force R acting on the fastening
- F_V ... Lateral component of the resulting force R acting on the fastening
- x ... Lever of the vertical component F_V (= distance to top surface of base material)

Structural check has to be made following the interaction rules given in Table 4.

2.5 Grounding and bonding restrictions

The data given in chapter 2.6 of [1] was verified only for fasteners with sealing washer. Therefore, the fasteners without sealing washers – including the NQA-1-2000 compliant fasteners of this supplement – are not allowed to be used for grounding and bonding purpose.

3 Literature

[1] Hilti Corporation (2010): *Hilti X-BT Threaded Fastener Specification*, Edition December 2010

[2] Hilti Corporation (2011): *Hilti X-BT Threaded Fastener Specification, Supplement 11/2011: Use in spheroidal cast iron, approval update – fatigue classification*, November 2011

[3] ANSI / ASME NQA-1-2000: *Quality Assurance Program for Nuclear Facilities*