

HILTI

PS 250 / PS 200 S

Bedienungsanleitung	de
Operating instructions	en
Mode d'emploi	fr
Istruzioni d'uso	it
Manual de instrucciones	es
Manual de instruções	pt
Instrukcja obsługi	pl
Инструкция по эксплуатации	ru
Kullanma Talimatı	tr
取扱説明書	ja
사용설명서	ko
操作說明書	zh
操作说明书	cn



1

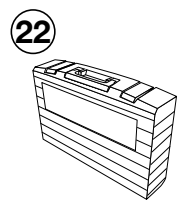
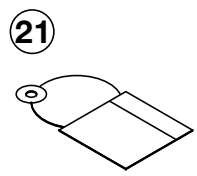
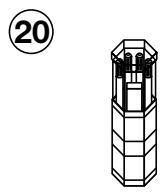
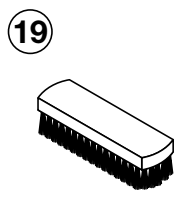
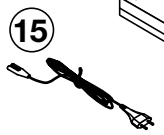
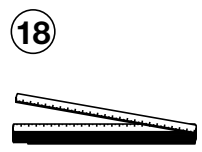
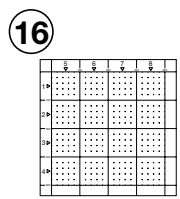
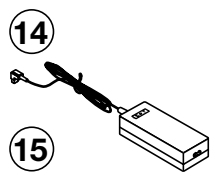
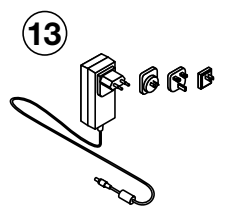
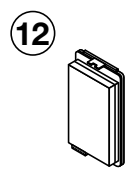
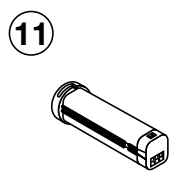
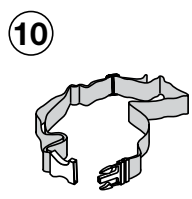
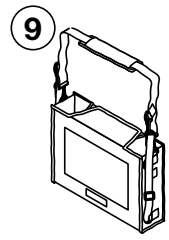
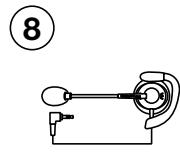
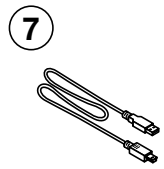
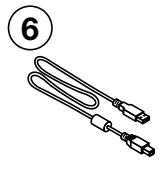
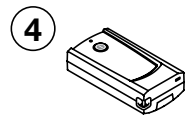
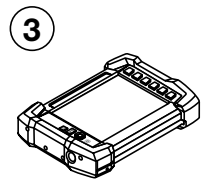
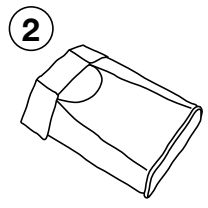
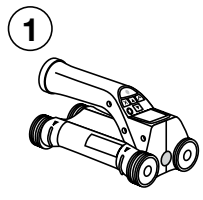

2

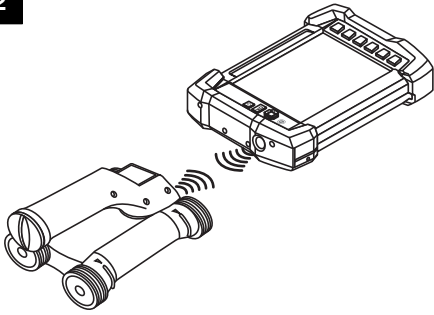

3

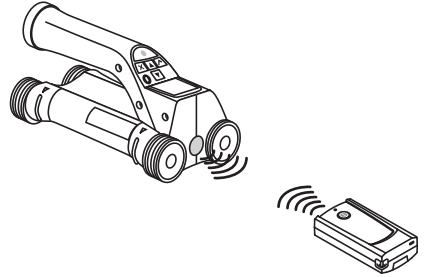

4

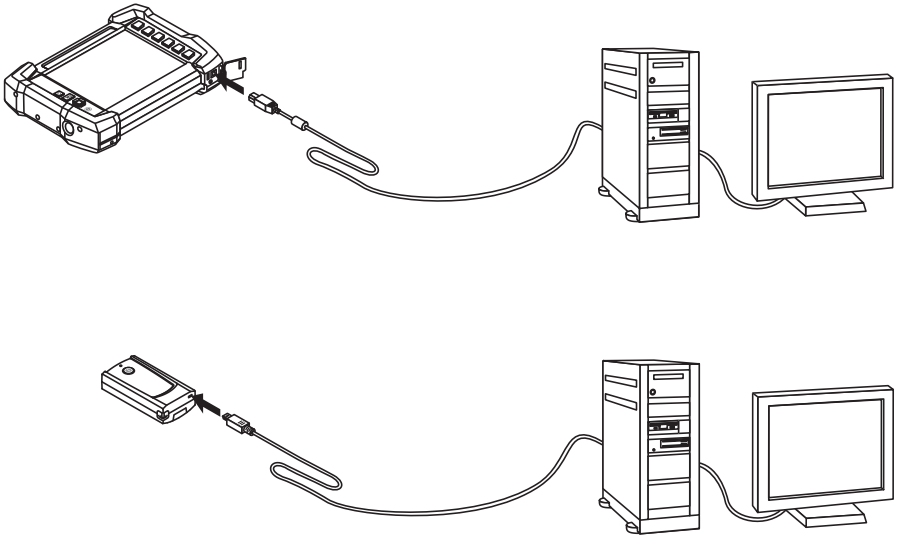

ORIGINAL OPERATING INSTRUCTIONS

PS 250 ferroskan system

PS 200 S ferroskan

en

It is essential that the operating instructions are read before the tool is operated for the first time.

Always keep these operating instructions together with the tool.

Ensure that the operating instructions are with the tool when it is given to other persons.

Contents	Page
1 General information	34
2 Description	35
3 Items supplied, accessories, spare parts	36
4 Technical data	40
5 Safety instructions	43
6 Before use	44
7 Operation	45
8 Care and maintenance	61
9 Troubleshooting	62
10 Disposal	64
11 Manufacturer's warranty	65
12 EC declaration of conformity (original)	65

I These numbers refer to the illustrations. You can find the illustrations at the beginning of the operating instructions.

In these operating instructions, the designation "the tool" always refers to PS 200 S Ferroskan. The designation

"PS 250 Ferroskan system" applies to the whole system consisting of the PS 200 S scanner, PSA 100 monitor and PROFIS Ferroskan PC software for data evaluation. The designation "PS 200 S Ferroskan", on the other hand, applies only to the scanner.

Components **I**

- ① PS 200 S scanner
- ② PSA 60 soft pouch
- ③ PSA 100 monitor
- ④ PSA 55 infrared adapter
- ⑤ PSA 63 hand strap
- ⑥ PSA 92 USB data cable
- ⑦ PUA 95 Micro USB data cable
- ⑧ PSA 93 headset with microphone
- ⑨ PSA 64 soft pouch
- ⑩ PSA 62 carrying strap
- ⑪ PSA 80 battery pack
- ⑫ PSA 82 battery pack
- ⑬ PUA 81 AC adapter
- ⑭ PUA 80 charger
- ⑮ Supply cord
- ⑯ PSA 10/11 reference grid set
- ⑰ PUA 90 adhesive tape
- ⑱ Folding rule
- ⑲ PSA 70 brush
- ⑳ PUA 70 marking pen set
- ㉑ PROFIS Ferroskan software
- ㉒ PS 250 toolbox

1 General information

1.1 Safety notices and their meaning

DANGER

Draws attention to imminent danger that will lead to serious bodily injury or fatality.

WARNING

Draws attention to a potentially dangerous situation that could lead to serious personal injury or fatality.

CAUTION

Draws attention to a potentially dangerous situation that could lead to slight personal injury or damage to the equipment or other property.

NOTE

Draws attention to an instruction or other useful information.

1.2 Explanation of the pictograms and other information

Warning signs



General warning



Warning: electricity



Warning: caustic substances

Obligation signs



Read the operating instructions before use.

Symbols



Return materials for recycling

Location of identification data on the tool

The type designation and serial number can be found on the type identification plate on the tool. Make a note of this data in your operating instructions and always refer to it when making an enquiry to your Hilti representative or service department.

Type: _____

Generation: 02 _____

Serial no.: _____

en

2 Description

2.1 Use of the product as directed

The tool is intended to be used for locating reinforcing bars in concrete, measuring depth of concrete cover and estimating the diameter of the bars in the uppermost layer in accordance with the specifications detailed in the technical data provided in these operating instructions.

The tool is designed for professional use and may be operated, serviced and maintained only by trained, authorized personnel. This personnel must be informed of any special hazards that may be encountered. The tool and its ancillary equipment may present hazards when used incorrectly by untrained personnel or when used not as directed.

Observe the information printed in the operating instructions concerning operation, care and maintenance.

Take the influences of the surrounding area into account. Do not use the tool or appliance where there is a risk of fire or explosion.

Modification of the tool or tampering with its parts is not permissible.

2.2 PSA 55 infrared adapter

The PSA 55 infrared adapter is used to store scans before they are subsequently transferred to a computer. The adapter has a storage capacity of approx. 100 scans.

2.3 Applications

The tool can be used for various non-destructive detection applications on steel-reinforced concrete structures (e.g. locating reinforcing bars in the uppermost layers, measuring depth of concrete cover and estimating the diameter of the bars detected). The scanning mode used depends on the application. These fall broadly into the following categories:

Application	Scanning mode
Avoiding damage to reinforcing bars when drilling or core drilling	Quickscan detection, Imagescan or Blockscan
Determining the position / number and diameter of bars for load-bearing capacity checks or depth of cover measurements	Imagescan
Determining depth of concrete cover over large areas	Quickscan recording

2.4 Using the system

The system functions by running the scanner directly over the surface of the structure. The data collected is stored in the scanner until it can be transferred to the monitor. The monitor is used for storing large amounts of data and for viewing the scans. It can also be used for on-the-spot evaluation of scans. The data can also be downloaded to a PC. The PC software offers advanced evaluation options, data archiving functions and the ability to quickly print out complete reports.

2.5 Quickscan detection

The scanner is moved across the surface at right angles to the reinforcing bars. The position and approximate depth of the reinforcing bars can be determined and marked right away on the surface of the concrete.

2.6 Quickscan detection with accurate depth measurement

Before scanning, the operator is required to enter values for the diameter of the reinforcing bars and the spacing between the bars. The scan is then carried out as described for Quickscan detection.

2.7 Quickscan recording

Data is recorded automatically as the scanner is moved over the surface of the concrete. This data is subsequently transferred to the monitor where it can be evaluated and the average depth of cover determined. If the data is downloaded to a PC, the information can be evaluated, archived and a report printed. Further evaluation options allow Quickscan recordings to be imported and evaluated automatically, statistical evaluations prepared and scans displayed in the form of large-area evaluations.

2.8 Imagescan

A reference grid is attached at the area of interest using the adhesive tape supplied. After selecting the Imagescan mode with the scanner, the rows and columns of the grid are scanned following the instructions on the screen. The data is transferred to the monitor where the image can be viewed and evaluated. The position of the reinforcing bars relative to the concrete surface is indicated. Bar diameter can be estimated and bar depth determined. If the data is downloaded to the PC application, this information can be evaluated as on the monitor, with the additional advantage of allowing a series of points to be recorded along with associated depth and diameter, and the data saved for future use. Reports can also be printed. Further evaluation options allow Imagescans to be imported and evaluated automatically, statistical evaluations prepared and scans displayed in the form of large-area evaluations.

2.9 Blockscan

A reference grid is attached at the area of interest using the adhesive tape supplied. After selecting Blockscan mode, the user is prompted to select the first area to scan. An Imagescan is then made. After completing the Imagescan, the user is prompted to select the next area to scan. This should be adjacent to the previous area. Attach the grid and then scan as before. This procedure can be repeated for up to 3 x 3 Imagescans. The data is transferred to the monitor. The Imagescans are automatically stitched together to form a larger image. The reinforcement layout can then be viewed over the whole area. Individual Imagescans can be selected for evaluation by "zooming in". If the data is downloaded to the PC application, this information can be evaluated as on the monitor, with the additional advantage of allowing a series of points to be recorded along with associated depth and diameter, and the data saved for future use. Reports can also be printed.

3 Items supplied, accessories, spare parts

3.1 Items supplied

3.1.1 PS 250 Ferrosan system

Num-ber	Designation	Comments
1	PS 200 S scanner ¹	
1	PSA 60 soft pouch	Soft pouch for the PS 200 S scanner
1	PSA 100 monitor ¹	
1	PSA 64 soft pouch	Soft pouch for the PSA 100 monitor
1	PSA 63 hand strap	For the PS 200 S scanner
1	PSA 55 infrared adapter	For temporary storage of data from the PS 200 S scanner

¹ Version depends on the country-specific version of the system ordered.

² May or may not be included in the items supplied, depending on the country-specific version of the system ordered.

Number	Designation	Comments
1	PUA 95 Micro USB data cable	Data cable for connecting the PSA 55 infrared adapter to a PC
1	PSA 97 data module	Contains the operating instructions in electronic form and is used to update the PSA 100 monitor
1	PSA 92 USB data cable	PSA 100 monitor to PC
1	PSA 93 headset with microphone	For the PSA 100 monitor
2	AA-size alkaline batteries	For the PSA 55 infrared adapter
1	PSA 80 battery pack	NiMH battery pack for the PS 200 S scanner
1	PUA 80 charger	Charger for the PSA 80 battery pack
1	Supply cord ¹	Supply cord for the PUA 80 charger
1	PSA 82 battery pack	Li-ion battery pack for the PSA 100 monitor
1	PUA 81 AC adapter	AC adapter for charging the PSA 100 monitor
1	PSA 75 brush	For removing dust and particles of concrete before applying PUA 90 adhesive tape
1	Cleaning cloth	
1	Folding rule ²	
5	PSA 10/11 reference grid ¹	For making an Imagescan
1	PUA 90 adhesive tape	For attaching the reference grid to a dry, dust-free concrete surface
1	PUA 70 marking pen set	Set of 6 red and 6 black marking pens for marking the grid position and object position
1	PROFIS Ferroskan software	PC software on CD-ROM for the PS 250 Ferroskan system / PS 200 S Ferroskan set
1	PSA/PUA operating instructions	
1	PSA 100 operating instructions	
1	PS 200 S Ferroskan / PS 250 Ferroskan system operating instructions	
1	PS 200 S manufacturer's certificate	
1	PSA 100 manufacturer's certificate	
1	PS 250 toolbox	Plastic toolbox with insert for the PS 250 Ferroskan system
¹ Version depends on the country-specific version of the system ordered.		
² May or may not be included in the items supplied, depending on the country-specific version of the system ordered.		

3.1.2 PS 200 S Ferroskan set

Number	Designation	Comments
1	PS 200 S scanner ¹	
1	PSA 55 infrared adapter	For temporary storage of data from the PS 200 S scanner
1	PSA 60 soft pouch	Soft pouch for the PS 200 S scanner
1	PSA 62 carrying strap	
1	PSA 63 hand strap	Soft pouch for the PS 200 S scanner
2	AA-size alkaline batteries	
1	PSA 80 battery pack	NiMH battery pack for the PS 200 S scanner
1	PUA 80 charger	Charger for the PSA 80 battery pack
1	PUA 95 Micro USB data cable	Data cable for connecting the PSA 55 infrared adapter to a PC
5	PSA 10/11 reference grid ¹	For making an Imagescan
1	PUA 90 adhesive tape	For attaching the reference grid to a dry, dust-free concrete surface
1	PUA 70 marking pen set	Set of 6 red and 6 black marking pens for marking the grid position and object position
1	PROFIS Ferroskan software	PC software on CD-ROM for the PS 250 Ferroskan system / PS 200 S Ferroskan set
1	PSA/PUA operating instructions	
1	PS 200 S Ferroskan / PS 250 Ferroskan system operating instructions	
1	PSA 75 brush	For removing dust and particles of concrete before applying PUA 90 adhesive tape
1	Folding rule ²	
1	Cleaning cloth	
1	PS 200 S toolbox	Plastic toolbox with insert
1	PS 200 S manufacturer's certificate	
¹ Version depends on the country-specific version of the system ordered.		
² May or may not be included in the items supplied, depending on the country-specific version of the system ordered.		

3.1.3 PS 200 S scanner

Number	Designation	Comments
1	PS 200 S scanner ¹	
1	PSA 60 soft pouch	Soft pouch for the PS 200 S scanner
1	PSA 80 battery pack	NiMH battery pack for the PS 200 S scanner
1	PSA 63 hand strap	For the PS 200 S scanner
¹ Version depends on the country-specific version of the system ordered.		

Number	Designation	Comments
1	PSA/PUA operating instructions	
1	PS 200 S Ferroskan / PS 250 Ferroskan system operating instructions	
1	PS 200 S manufacturer's certificate	

¹ Version depends on the country-specific version of the system ordered.

3.2 Accessories and spare parts

Item no.	Designation	Comments
2006082	PSA 100 monitor	PSA 100 monitor, PSA 82 battery pack, PUA 92 USB data cable, PSA 97 data module, manufacturer's certificate, operating instructions, packed in a cardboard box
377654	PSA 10 reference grid	Reference grid in mm (in packs of 5)
377655	PSA 11 reference grid	Reference grid in inches (in packs of 5)
319362	PUA 90 adhesive tape	For attaching the reference grid to a dry, dust-free concrete surface
340806	PUA 70 marking pen set	For marking the grid position and object position (12 pens)
305144	PSA 63 hand strap	For the PS 200 S scanner
377657	PSA 60 soft pouch	For the PS 200 S scanner
2006088	PSA 64 soft pouch	For the PSA 100 monitor
319412	PSA 62 shoulder strap	For carrying the PS 200 S scanner
2004459	PUA 81 AC adapter	For charging the PSA 100 monitor
¹	PUA 80 charger	For charging the PSA 80 battery pack, incl. supply cord
2006180	PUA 82 motor vehicle power adapter	AC adapter for charging the PSA 100 monitor
377472	PSA 80 battery pack	For the PS 200 S scanner
416930	PSA 82 battery pack	For the PSA 100 monitor
2006183	PSA 85 charger	Charger for the PSA 82 battery pack
2013775	PSA 92 USB data cable	For transferring data from the PSA 100 monitor to a PC
2031976	For data transfer from the PUA 95 Micro USB data cable	PSA 55 infrared adapter for PC
305143	PSA 93 headset	For the PSA 100 monitor
2006187	PSA 55 infrared adapter	For temporary storage of data from the PS 200 S scanner
2006191	PSA 97 data module	Contains the operating instructions in electronic form and is used to update the PSA 100 monitor
2006200	PSA 65 carrying device	For the PSA 100 monitor
319416	Hilti PROFIS Ferroskan PC software	PC software on CD-ROM for the PS 250 Ferroskan system / PS 200 S scanner set
2031824	Hilti toolbox for PS 250	
2044483	Hilti toolbox for PS 200 S	

Item no.	Designation	Comments
2013776	PSA 75 brush	For removing dust and particles of concrete before applying PUA 90 adhesive tape
276946	Folding rule	
2005011	Cleaning cloth	
2004955	PSA/PUA P1 operating instructions	For Europe / Asia
2012529	PSA/PUA P2 operating instructions	For USA / Canada
2004954	PSA 100 P1 operating instructions	For Europe / Asia
2004815	PSA 100 P2 operating instructions	For USA / Canada
2037330	PS 200 S Ferroskan / PS 250 Ferroskan system P1 operating instructions	For Europe / Asia
2037331	PS 200 S Ferroskan / PS 250 Ferroskan system P2 operating instructions	For USA / Canada

4 Technical data

4.1 Ambient conditions

Operating temperature range	-10...+50°C
Storage temperature	-20...+60°C
Relative humidity (operation)	Max. 90%, no condensation
Dust and water protection (operation)	IP54
Impact resistance (tool in toolbox)	EN 60068-2-29
Dropping	EN 60068-2-32
Vibration (not in operation)	MIL-STD 810 D

4.2 System scanning performance

For reliable scanning results, the following conditions must be fulfilled:

- Concrete surface smooth and flat.
- Reinforcement not corroded.
- Reinforcement lying parallel to concrete surface.
- Concrete does not contain additives or components with magnetic properties.
- Reinforcing bars lying within $\pm 5^\circ$ of right angle to the scanning direction.
- Reinforcing bars are not welded.
- Neighboring bars are of similar diameter.
- Neighboring bars are at a similar depth.
- Accuracy specifications are valid only for the first layer of reinforcement.
- No interfering influences from external magnetic fields or objects nearby with magnetic properties.
- Bars have relative magnetic permeability of 85–105.
- The scanner wheels are clean and free from sand and grit etc.
- All 4 scanner wheels are in contact and rotate when the scanner is moved across the object to be scanned.
- The bars comply with one of the following standards (depending on system item no.):

Standards for steel reinforcing bars

Item no.	Standard	Origin / applicability of the standard
2044434, 2044439, 2044473, 2044435, 2044472, 377646, 377652	DIN 488	European Union and all other countries not listed below
2044436, 2044474, 377649	ASTM A 615 / A 615M-01b	United States of America, Taiwan, Latin America and Central America
2044437, 2044475, 377650	CAN/CSA-G30, 18-M92	Canada
2044438, 2044470, 2044476, 2044478, 377651	JIS G 3112	Japan, Korea
2044471, 2044479, 408056	GB 50010-2002	China
2078650, 2078660, 2078670	GOST 5781-82	Russia
2078651, 2078661, 2078671	BIS 1786:1985	India

en

4.3 Detection range, measurement range and accuracy

NOTE

If one or more of the specified conditions are not fulfilled, accuracy and precision may be compromised. The ratio of bar spacing to depth of cover ($s:c$) is often a limiting factor in resolving individual bars.

This is defined as:

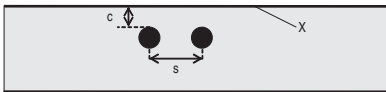

c	Depth of cover
s	Spacing
X	Surface

In order to be able to resolve and locate individual bars, the ratio of bar spacing (s) to depth of cover (c) must be at least 2:1. Minimum bar spacing is 36 mm. The higher of the two values applies when resolving individual bars. A depth of at least $c \geq 10$ mm is required in order to carry out a depth measurement.

NOTE

Place a sheet of non-metallic material (e.g cardboard, wood, polystyrene foam,...) between the scanner and the surface to be scanned if the minimum depth cannot be adhered to.

The starting point and finishing point of the scan (e.g. from the edge of the reference grid) must be at least 30 mm away from the nearest reinforcing bar.

In the annex of these operating instructions you will find bar diameter tables in accordance with:

- DIN 488
- ASTM
- CAN
- JIS
- GB 500110-2002
- GOST 5781-82
- BIS 1786:1985

Explanation of the bar diameter tables in the annex

\varnothing [mm]	Bar diameter in mm
--------------------	--------------------

∅	Bar diameter
↓ [mm]	Depth in mm
0	Bar is visible at this depth but no depth is calculated.
X	Bar cannot be detected at this depth.
The value indicates the typical accuracy of the depth measurement (deviation from actual) in mm.	

4.3.1 Imagescan and Blockscan: Rebar diameter is known

Please refer to the bar diameter tables in the annex (1.).

4.3.2 Imagescan and Blockscan: Rebar diameter is not known

Please refer to the bar diameter tables in the annex (2.).

4.3.3 Quickscan recording: Rebar diameter is known

Please refer to the bar diameter tables in the annex (3.).

4.3.4 Quickscan detection with depth measurement: Rebar diameter is known

Please refer to the bar diameter tables in the annex (4.).

4.3.5 Quickscan detection

Depth measurement is accurate to within $\pm 10\%$ of the effective depth.

4.3.6 Accuracy of bar diameter measurement

± 1 standard diameter when rebar spacing : depth of cover $\geq 2 : 1$. Bar diameter measurement is possible only at depths of up to 60 mm.

4.3.7 Reinforcing bar location accuracy

Bar center locating accuracy (all modes): Typically ± 3 mm relative to the measured position, when the ratio of bar spacing : depth of cover is $\geq 1.5:1$.

4.4 Technical data for PS 200 S scanner

Maximum scanning speed	0.5 m/sec
Memory type	Built-in flash memory for data
Memory capacity	9 Imagescans plus up to 30 m of recorded Quickscan (max. 10 scans)
Screen type / size	LCD / 50 × 37 mm
Screen resolution	128 × 64 pixels
Dimensions	260 × 132 × 132 mm
Weight (with PSA 80 battery pack)	1.4 kg
Minimum battery life (with PSA 80 battery pack)	8 hours under typical conditions
Automatic power-off	5 min. after last press of a button
Backup battery type / life	Lithium / 10 years (typically)
Scanner-monitor data interface	Infrared
Scanner-monitor data transfer time	≤ 16 s for 9 images, ≤ 2 s for 1 image
Infrared range	0.3 m (typically)
Infrared output power	Max. 500 mW

4.5 Technical data for PSA 55 infrared adapter

Battery	1 x 1.5 V AAA
Dimensions	90 x 50 x 28 mm
Weight	65 g
Scanner - adapter data interface	IrDa
Adapter - computer data interface	USB

5 Safety instructions

In addition to the information relevant to safety given in each of the sections of these operating instructions, the following points must be strictly observed at all times.

5.1 Intended use

- The tool and its ancillary equipment may present hazards when used incorrectly by untrained personnel or when used not as directed.**
- To avoid the risk of injury, use only genuine Hilti accessories and additional equipment.**
- Modification of the tool or tampering with its parts is not permissible.**
- Observe the information printed in the operating instructions concerning operation, care and maintenance.**
- Do not render safety devices ineffective and do not remove information and warning notices.**
- Check the condition of the tool before use. If the tool is found to be damaged, have it repaired at a Hilti Service Center.**
- In particularly critical situations where measurements have safety and structural stability implications, always check results by removing material from the surface of the structure and physically checking the position, depth and diameter of reinforcement at key positions.
- When drilling at or near to a bar indicated by the system, never drill deeper than the bar depth indicated.

5.2 Proper organization of the workplace

- Keep the workplace tidy. Objects which could cause injury should be removed from the working area.** Untidiness at the workplace can lead to accidents.
- Keep other persons, especially children, away from the area in which the work is being carried out.**
- Wear non-skid shoes.**
- Avoid unfavorable body positions when working from ladders. Make sure you work from a safe stance and stay in balance at all times.**
- Only use the tool within the defined limits.**
- Check with a qualified person that it is safe to drill at a specified point before beginning drilling.

- Do not use the tool where there is a risk of fire or explosion.**

- Make sure that the toolbox is properly secured during transport and does not present a risk of injury.

5.3 Electromagnetic compatibility

NOTE

Only for Korea: This device is suitable for the electromagnetic radiation encountered in residential environments (Class B). It is intended mainly for use in residential environments but may also be used in other environments.

Although the tool complies with the strict requirements of the applicable directives, Hilti cannot entirely rule out the possibility of interference to the tool caused by powerful electromagnetic radiation, leading to incorrect operation. Accuracy must be checked by taking measurements by other means when working under such conditions or if you are unsure. Likewise, Hilti cannot rule out the possibility of interference with other devices (e.g. aircraft navigation equipment).

5.4 General safety precautions

5.4.1 Mechanical safety precautions

- Check the tool for damage before use.** If the tool is found to be damaged, have it repaired at a Hilti Service Center.
- You must check the accuracy of the tool after it has been dropped or subjected to other mechanical stresses.**
- When the tool is brought into a warm environment from very cold conditions, or vice-versa, allow it to become acclimatized before use.**
- Although the tool is protected against the entry of moisture, it should be wiped dry before being put away in its transport container.**

5.4.2 Electrical safety precautions

- Avoid short circuiting the battery terminals.** Check that the terminals on the battery pack and in the tool are free from foreign objects before inserting the battery pack. Short circuiting the battery terminals presents a risk of fire, explosion and chemical burns.
- Make sure that the outer surfaces of the battery pack are clean and dry before inserting it in the**

charger. Observe the operating instructions for the charger.

- c) Use only the battery pack specified in these operating instructions.
- d) Batteries that have reached the end of their life must be disposed of safely and correctly to avoid environmental pollution.
- e) Remove the battery pack before transporting the tool or storing it for a long period of time. Inspect the battery pack for any signs of leakage or damage before reusing it.
- f) **To avoid pollution of the environment, the tool must be disposed of in accordance with the currently applicable national regulations. Consult the manufacturer if you are unsure of how to proceed.**

5.4.3 Liquids



Caustic liquids may leak from defective batteries. Avoid contact with these liquids. In case of skin contact, wash the area affected with soap and plenty of water. In case of eye contact, rinse the eyes immediately with water and subsequently consult a doctor.

5.5 Requirements to be met by users

- a) The tool may be operated, serviced and repaired only by authorized, trained personnel. This personnel

must be informed of any special hazards that may be encountered.

- b) **Concentrate on your work. Stay alert. Pay attention to what you are doing. Approach the work with common sense. Do not use the tool if you are not concentrating.**
- c) **Do not use the tool if it is defective.**
- d) If you are unsure of the scan results, consult a Hilti specialist before proceeding.
- e) Observe all warning and information messages displayed by the scanner and monitor.

5.6 Scanning requirements and limitations

- a) Always check the accuracy of the tool before commencing work on structures where measurements have safety and structural stability implications. Scan a reinforcing bar of known location, depth and diameter and check the results against the accuracy specifications.
- b) Do not use the PS 200 S scanner if the wheels do not turn freely or appear to be worn. Contact Hilti for repair information. The wheels may also be cleaned or replaced by the user.
- c) **Always check how the tool is configured before using it.**
- d) Apply only light pressure to the scanner when moving it across the surface.
- e) Reinforcement that lies beneath the uppermost layer of reinforcement may not be detected.
- f) Remove all metal items of jewelry such as rings, pendants, bracelets, etc. before commencing scanning.

6 Before use

6.1 Charging the battery pack

Use the PUA 80 charger to charge the PSA 80 battery pack. Full instructions are contained in the charger operating instructions. The battery pack must be charged for 14 hours before first use.

6.1.1 Inserting and removing the battery pack

CAUTION

The battery pack must slide easily into the scanner. Do not use force when inserting the battery pack into the scanner as this may damage the battery pack and/or the scanner.

Check that the battery pack is correctly aligned with the scanner. When the battery pack end cap is facing you, the large groove in the battery pack must be on the left.

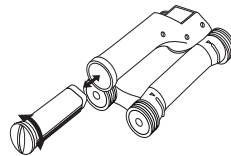

Push the battery pack into the opening as far as it will go. Turn the end cap clockwise until it clicks into place.

To remove the battery pack, turn the end cap anti-clockwise as far as it will go. Pull the battery pack out of the scanner.

7 Operation

7.1 Carrying and using the system

CAUTION

The temperature inside a motor vehicle exposed to the heat of the sun can easily exceed the maximum permissible storage temperature for the PS 250 Ferroscan system. Some of the components of the PS 250 Ferroscan system may suffer damage if exposed to temperatures exceeding 60°C.

The scanner can be used without the monitor for scanning, or the monitor can be carried in the PSA 64 soft

pouch. The first option is advantageous when working in areas that are difficult to access and maximum mobility is required, such as on a scaffold or ladder. When scanner memory is full (9 Imagescans made, 1 complete Blocks-can or 30 m of Quicksan have been recorded) the data can be transferred to the PSA 55 infrared adapter or the PSA 100 monitor. The monitor can be kept nearby (e.g. at the foot of the scaffold, in a vehicle, in the site office etc.). When the user intends to make more scans than the scanner is capable of storing in its memory and wishes to avoid repeated journeys to the monitor, the PSA 55 infrared adapter can be used or the monitor attached to a belt or carried using the shoulder strap supplied.

en

7.2 Operating the scanner

7.2.1 Control panel and display

Control panel

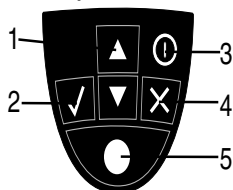

①	Arrow buttons	Toggle up or down in options or values.
②	Confirm button	Confirms a value or a selection.
③	On/off button	Switches the tool on or off.
④	Cancel button	Cancels an input, cancels the path being scanned or goes back one step within a menu.
⑤	Record button	Starts or stops a recording.

Display

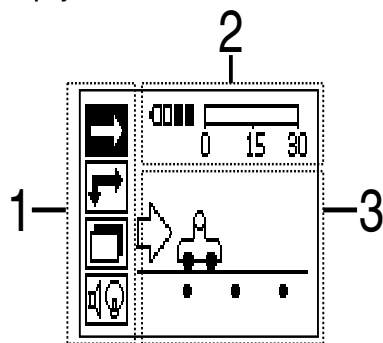

①	Menu area.	Functions that can be selected using the Arrow and Confirm buttons
②	Status information	Information such as battery charge status and memory status.
③	Variable area.	This is where feedback / information for the user is displayed, e.g. scanning mode, bar depth, scanning progress, etc.

7.2.2 Switching on and off

Press the on / off button to switch the scanner on or off.

The scanner can be switched off only when the main menu is displayed. To reach this screen, press the Cancel button repeatedly until the main menu is displayed.

7.2.3 Main menu

The system always starts in the main menu. All scanning functions and set-up options are selected here. The battery charge status is displayed at the top of the screen together with the memory status. The various scan modes and

settings menus are displayed as symbols on the left side of the screen. Use the Arrow buttons to toggle between these options. Press the Confirm button to confirm the selected option.

Quickscan

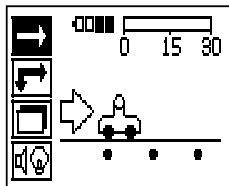

The remaining memory for Quickscan recording is shown at the top of the screen in meters or feet (depending on the scanner type and units set).

Imagescan

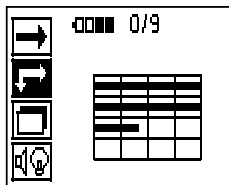

The number of Imagescans in the scanner, up to a maximum of 9, is shown at the top of the screen.

Blockscan

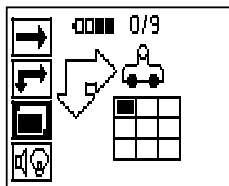

The number of Imagescans in the scanner, up to a maximum of 9, is shown at the top of the screen.

Settings

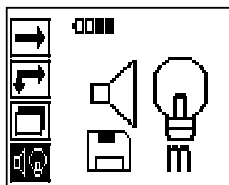

Sets various parameters and deletes all scans held in memory.

7.2.4 Settings

This menu is used to set general parameters and to delete data from scanner memory. After opening the settings menu, this screen appears.

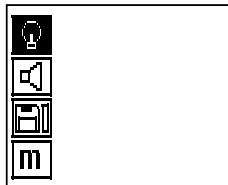

The Arrow buttons are used to select the options. The selected option can be confirmed / activated by pressing the Confirm button and the Cancel button then pressed to return to the main menu.

7.2.4.1 Set display backlight

Select the backlight adjustment function by pressing the Confirm button. Use the Arrow buttons to toggle between the individual options. Press the Confirm button to select the desired option and press the Cancel button to return to the settings menu.

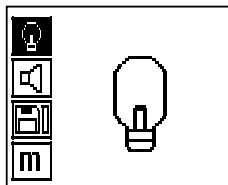

Switch backlight on

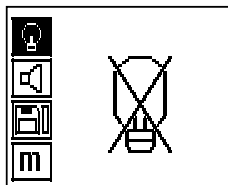

Switch backlight off

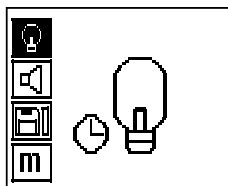

Backlight is controlled automatically. With this option, the backlight is switched off automatically after 5 minutes if no button is pressed during this time and is switched back on again the next time a button is pressed.

7.2.4.2 Adjusting the volume

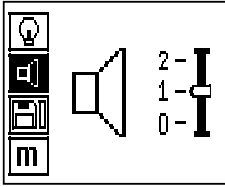

en

Sets the volume level of the audible signal during scanning. Use the Arrow buttons to toggle between the various options. Press the Confirm button to select the desired option and press the Cancel button to return to the settings menu.

7.2.4.3 Setting the units

On systems with the item nos. 2044436, 2044474 and 377649 can the unit of measure used for scanning can be configured by the user. Use the Arrow buttons to toggle between the various options. Press the Confirm button to select the desired option and press the Cancel button to return to the settings menu.

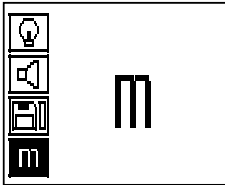

Metric (mm or m, as appropriate)

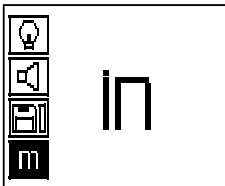

Imperial (feet, as appropriate)

7.2.4.4 Deleting data

Deletes **all** scan data stored in the scanner. This function is available only if data is contained in memory. If data is contained in memory, the bar shown next to the diskette symbol is filled. The bar is shown empty when no data is contained in memory.

NOTE

Deleting memory contents presents a risk of losing data. Data that has not been transferred to the monitor before deletion will be permanently lost.

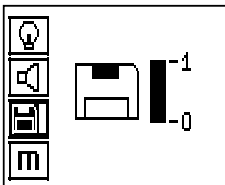

Press the Down arrow button followed by the Confirm button to delete data. Alternatively, press the Cancel button to return to the settings menu.

7.2.5 Quickscan

CAUTION

The scanner detects only reinforcing bars that lie at right angles to the direction of travel. Bars that lie parallel to the direction of travel will not be detected.

Make sure that the object is scanned in both the horizontal and vertical directions.

An incorrect depth may be calculated for bars that lie diagonal to the direction of travel.

en

Quickscan can be used to quickly detect the positions and approximate depths of reinforcing bars, which can then be marked on the surface. This procedure is named Quickscan detection.

Another function in Quickscan mode is accurate depth measurement, which requires that values for bar diameter and bar spacing are previously entered.

Alternatively, the data can be recorded and evaluated on the monitor or using the PC application. The average depth of cover over the reinforcement over large stretches of the surface can thus be easily determined. This procedure is known as Quickscan recording.

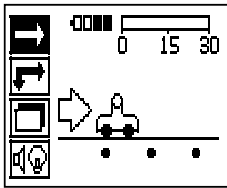

Switch on the scanner. The Quickscan symbol is selected first automatically. Use the Confirm button to select the Quickscan function from the main menu.

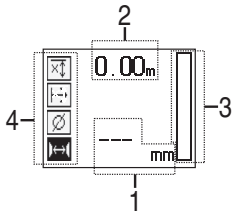

- | | |
|---|--|
| ① | Bar depth |
| ② | Distance traveled |
| ③ | Signal strength |
| ④ | Settings: Minimum depth, scanning direction, bar diameter, bar spacing |

7.2.5.1 Quickscan detection

Move the scanner over the surface. Reinforcing bars that lie at right angles to the direction of travel will be detected. The distance covered by the scanner is recorded.

Signal strength indicated by the column in the display increases as the scanner approaches a bar and the depth value is also shown. When the scanner is positioned over the center of a reinforcing bar:

- The red LED lights.
- A signal tone is emitted.
- Maximum signal strength is indicated.
- The approximate depth of the bar is indicated (lowest depth value indicated = center of the bar).

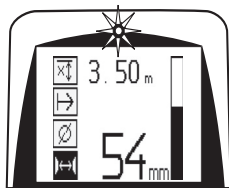

The bar is positioned along the center line of the scanner and may be marked on the surface using a PUA 70 marking pen. Depth measurement accuracy can be increased by entering the correct rebar diameter or by switching to accurate depth measurement measuring mode (see 7.2.5.2).

7.2.5.2 Quickscan with accurate depth measurement

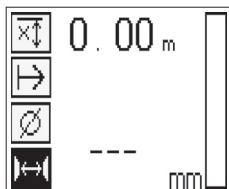

The measuring mode "Quickscan with accurate depth measurement" is selected by pressing the Confirm button.

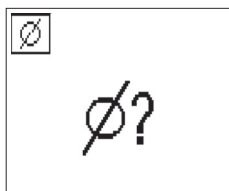

The correct diameter must be known and previously entered.

The bar spacing distance must also be entered if within the $36\text{ mm} \leq s \leq 120\text{ mm}$ range (see 4.3). This value can be taken from building plans, confirmed by chipping away a channel in the concrete to view the bars, or measured using Quickscan detection.

NOTE

A rebar spacing distance $s \leq 36\text{ mm}$ (see 4.3) cannot be measured.

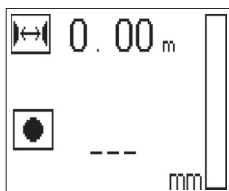

The bar spacing distance can be calculated automatically using the Quickscan detection function by searching for the center of the bar and pressing the red Record button when the scanner is over the mid point of the bar. Find the mid point of the next bar and then press the Record button again. Bar spacing is then calculated automatically and recorded.

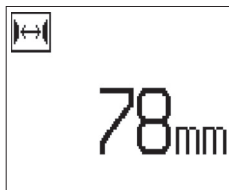

If the spacing distance is known, the value can also be entered manually using the Arrow buttons.

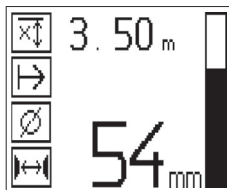

After setting the bar diameter and the spacing distance, the procedure is exactly the same as for Quickscan detection (see 7.2.5.1).

7.2.5.3 Quickscan recording

WARNING

Always make an Imagescan or use Quickscan detection in both directions prior to making a Quickscan recording in order to:

- establish the direction of the uppermost layer of reinforcement,
- minimize the risk of scanning a spliced bar,
- and immediately see if there are any ferrous materials in the concrete that may affect the accuracy of the scan.

CAUTION

Do not press the Record button before placing the scanner at the point where the scan should begin.

The scan should not, under any circumstances, be started or stopped while the scanner is directly over a bar. Keep an eye on the display (observe a distance of at least 30 mm to the nearest reinforcing bar).

Incorrect or misleading measurements may otherwise result.

WARNING

Do not lift the scanner from the surface before stopping the recording or setting a marker.

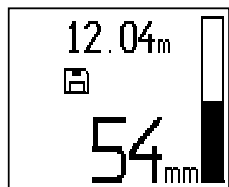

To record the position and depth of all reinforcing bars detected, place the scanner on the surface and use Quickscan detection to find a position where there are no bars present. Mark the starting point with a PUA 70 marking pen and press the Record button. The diskette symbol appears on the screen, indicating that the scanner is recording data. Move the scanner over the surface.

At the end of the scan, take care to ensure that the end point is not directly over a rebar. To stop recording, press Record again. Use a PUA 70 marking pen to mark the end of the stretch that has been scanned.

NOTE

Reinforcing bars that lie at right angles to the direction of travel will be detected and automatically recorded. Check to ensure that the settings are correct before beginning recording.

A stretch of up to 30 m in length can be recorded before it is necessary to transfer the data to the PSA 100 monitor or the PSA 55 infrared adapter. It is also possible to record several separate stretches (max. 10) that add up to a maximum of 30 m.

The data recorded can be transferred to the monitor for analysis (see section 7.4.1).

7.2.5.4 Quickscan settings

The Quickscan settings are shown on the left hand side of the display. The settings can be made before making a Quickscan or a Quickscan with accurate depth measurement. Use the Arrow buttons and Confirm button to access the settings.

Limited depth scan

NOTE

This measurement mode allows rebars to be located within a specified depth range.

NOTE

When using the tool in this mode, the preset depth must take a clearance distance from the rebar into account.

Minimum depth

Use this setting when scanning a surface and looking specifically for bars that are located within a certain depth. For example, if checking for 40 mm minimum depth of cover, set the value to 40 mm. (For quality assurance measurements add an extra 2 mm to account for any accuracy limitations). A signal tone is emitted and the LED lights only if a reinforcing bar located within 40 mm of the surface is detected.

CAUTION

Before making a scan, check to ensure that the depth range restriction is set correctly or deactivated if this feature is not required.



Use the Arrow buttons to select the minimum depth function and then press Confirm.

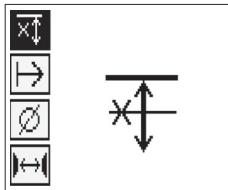

Minimum depth function disabled.

When the value is set to "0", the function is deactivated and appears as above. Use the Arrow buttons to enter the desired depth value and then confirm the setting by pressing the Confirm button. The system returns to the main menu.

NOTE

If reinforcing bars are located at depths greater than the minimum depth set, no signal tone is emitted and no LED lights.

Scanning direction

This setting is used to set the direction in which Quickscan recording is performed. Although they have no direct effect on any measurement values later obtained from the monitor or PC application, the settings help to ensure that

individual Quickscan recordings are subsequently correctly displayed in Hilti PROFIS Ferroskan MAP (data evaluation and presentation application) and that the depth values correspond with the actual surface of the structure. This makes it easier to subsequently locate the positions of areas with inadequate cover. The scanning direction is saved together with each scan.

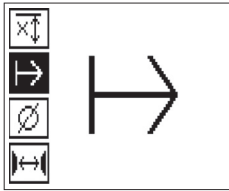

en

Select the desired scanning direction and press the Confirm button.

Bar diameter

This setting must be made in order to obtain an accurate depth of cover measurement (= rebar depth). Depth can be measured accurately only when correct rebar diameter has been entered.

Use the Arrow buttons to select the bar diameter function and then press the Confirm button.

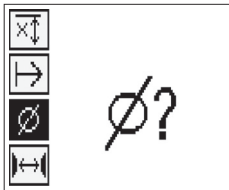

If no bar diameter is selected, the scanner will take the average diameter value for the relevant standard setting range and calculate the depth accordingly.

CAUTION

Use the “Unknown diameter” function only under exceptional circumstances as the results of the scan may be distorted considerably if rebars of a different diameter have, in fact, been incorporated in the structure.

Average bar diameter according to standards

Standard	∅
DIN 488	16 mm
ASTM A 615 / A 615M-01b	#7
CAN / CSA-G30, 18-M92	C 20
JIS G 3112	D 22
GB 50012-2002	18 mm
GOST 5781-82	18 mm
BIS 1786:1985	16 mm

NOTE

The bar diameter previously set will be saved in the scanner when switching it off. Check each time before using the scanner that the rebar diameter has been preset correctly.

7.2.5.5 Setting a marker

The surfaces of many structures contain obstacles that make it impossible to record the scan without lifting the scanner from the surface. Examples of such obstacles are piers or columns on a wall, door openings, expansion joints, pipes, scaffold bars, corners etc.

If an obstacle is encountered, a marker can be set. This interrupts the scan and allows the user to lift the scanner away from the surface, place it beyond the obstruction and then continue scanning. It also indicates where certain objects are located within a scan, providing additional information that creates a reference between the scan data and the actual surface.

en

To set a marker, press and hold the Confirm button while in recording mode. The diskette symbol will be crossed out, indicating that recording has been suspended and a marker has been set.

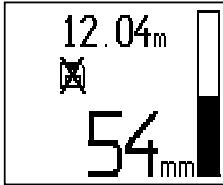

CAUTION

Due to interruption of the recorded signal, scanning results are less accurate immediately before and after the point where a marker is set.

Do not interrupt the scan at the position of a reinforcing bar.

Then lift the scanner from the surface while keeping the Confirm button pressed. If necessary, mark the position on the surface using a PUA 70 marking pen. Place the scanner back on the surface beyond the obstacle, release the Confirm button and continue scanning. The marker will be shown as a vertical line in the scan data when viewed on the monitor or in the PC application.

7.2.6 Imagescan

Imagescan is used to create an image of the reinforcement layout. The depth and diameter of the bars can be determined or, respectively, estimated.

A reference grid must first be fixed to the wall. Use the adhesive tape supplied for this purpose. This tape adheres well to concrete and can be torn off the roll by hand in the lengths required. For most surfaces, a 10 cm length of tape at each corner is adequate to secure the grid. If the concrete surface is very damp or dusty, use the brush supplied to clean off any dirt and dust. The reference grid may then have to be attached by applying a strip of tape along the full length of each edge.

Alternatively, a grid can be marked directly on the surface. Using a straight edge (such as a piece of wood) as a guide, mark out a 4 x 4 grid with the parallel lines spaced at intervals of 150 mm. The holes punched in the paper reference grid can also be used to mark the positions of the grid lines on the concrete surface.

Switch the scanner on and select the Imagescan symbol. The battery level is displayed together with the number of Imagescans currently held in memory (a maximum of 9).

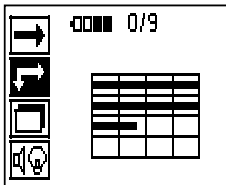

Select Imagescan from the main menu.
The Imagescan screen is displayed.

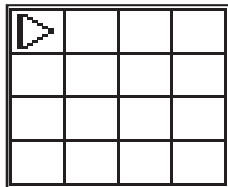

A representation of the grid appears on the screen with a suggested starting point (triangle). This is always at upper left and will be suitable for most scans. Image data will be generated only for areas of the grid that have been scanned both vertically and horizontally. In some cases, obstacles in the scan area may prevent this (e.g. a pipe penetrating a beam). The starting point may be changed in such cases in order to allow the area to be scanned optimally. Use the Arrow buttons to change the starting point if necessary.

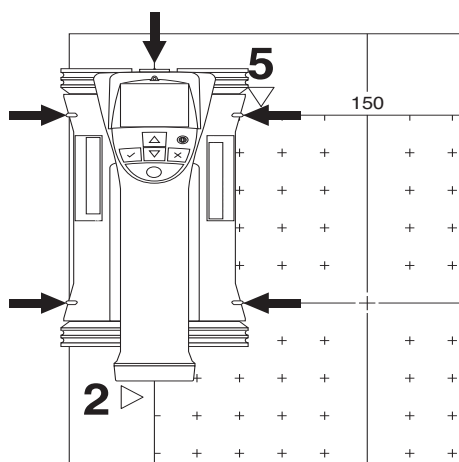

Place the scanner on the grid at the starting point shown by the blinking arrow. Ensure the alignment marks on the scanner are aligned correctly with the reference grid as shown above.

NOTE

Incorrect alignment of the scanner on the reference grid may lead to the bar positions being incorrect in the image generated.

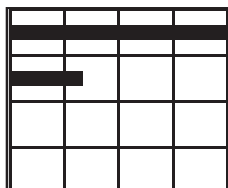

Press Record and move the scanner along the first row. Scanning progress is indicated by a thick black line that advances across the display as the scanner is moved over the surface.

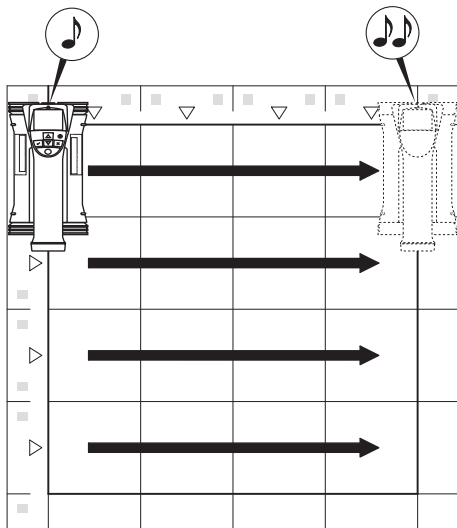

The scanner emits a double beep at the end of the row and automatically stops recording. This procedure should be repeated for each row and column while observing the instructions shown in the display.

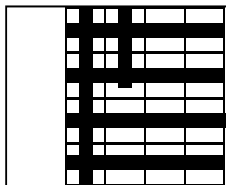

When all rows have been completed, the columns should also be scanned in the same way.

The scanning operation for any row or column may be interrupted before reaching the end by pressing Record again. This may be necessary if an obstacle prevents the full path being scanned. Similarly, an entire row or column may be skipped by starting and stopping the recording without running the scanner over the grid. Please note that no image will be created for areas of the reference grid that are not scanned in both directions.

It is possible to repeat the previous row or column by pressing Cancel. This may be necessary if the user is not sure whether the path to be scanned has been followed accurately or if the scanner slipped out of position. Pressing Cancel a second time aborts the scan and the system then returns to the main menu. Press Confirm to save the scan. Pressing Cancel after scanning the last column or row will cause the scan to be deleted.

When the scan is complete, press the Confirm button to return to the main menu. The data can be transferred to the monitor for viewing and evaluation (see 7.4.1).

7.2.7 Blockscan

Blockscan automatically stitches Imagescans together to provide an impression of the reinforcement layout over a large area. The exact bar position, depth and diameter can also be determined on the monitor by selecting each Imagescan individually.

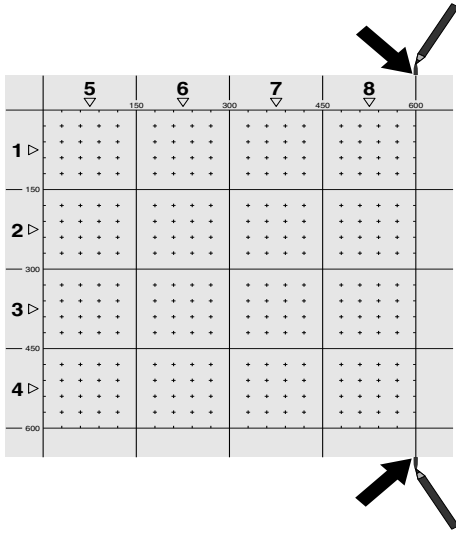

en

Attach the reference grid in the same way as for an Imagescan. Use a PUA 70 marking pen to mark the edges or the punched holes at the end of each reference grid for the transition to the next grid, as shown below. Any additional reference grids required should be attached to the wall so that their edges correspond and are in alignment with each other.

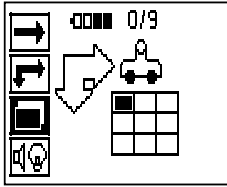

Switch the scanner on and use the Arrow buttons to select the Blockscan symbol from the main menu. The battery level is displayed together with the number of Imagescans currently held in memory (a maximum of 9).

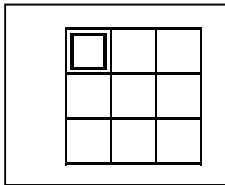

A representation of a Blockscan is shown on the screen. Each square represents an Imagescan. Up to 3 x 3 Imagescans can be made. Use the Arrow buttons to select the position of the first Imagescan to be made. Press Confirm to begin the first Imagescan. Note that the coordinates of any points on the Blockscan will be referenced from the upper left corner.

For details of how to carry out the Imagescan, see 7.2.6. When the Imagescan is complete, the system returns to the Blockscan screen.

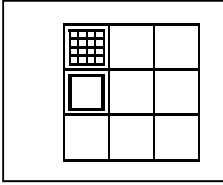

The completed Imagescan is shown shaded.

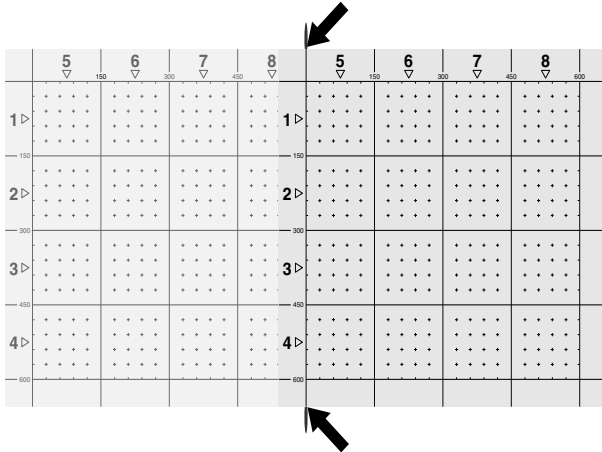

Select the next Imagescan position and repeat the scanning procedure. Imagescans already made may be repeated simply by reselecting the area to scan and carrying out the Imagescan again. The data will be overwritten. Once all the Imagescans have been recorded, or the maximum number of scans that can be held in memory is reached (9), press the Cancel button to return to the main menu. Transfer the data to the monitor for viewing and analysis (see 7.4.1).

NOTE

Pressing the Cancel button twice causes the recorded Imagescan to be deleted. The screen then returns to the main menu.

7.3 PSA 55 infrared adapter

7.3.1 Before first use

NOTE

Install the Hilti PROFIS Ferroskan 5.7 software (or a higher version) on your PC/laptop. The date and time must be set before using the PSA 55 IR adapter for the first time in order to ensure that the scan data subsequently shows the correct date and time.

- To do this, use the PUA 95 Micro USB cable to connect the PSA 55 IR adapter to the computer.
- Start the Hilti PROFIS Ferroskan application.
- Go to "Tools", "Workflow" and then select "Set PSA 55 date and time".

The date and time are then set in the PSA 55 IR adapter.

NOTE

The device driver is installed together with the Hilti PROFIS Ferroskan (V 5.7) software. If this is not the case, the device driver must be installed manually by running the "setup.exe" file located in the "Drivers" folder on the PSA 55 IR adapter.

7.3.2 Operating the PSA 55 infrared adapter

The scans can be transferred to the adapter via the infrared interface and from there to the PC/laptop.

Switch the adapter on or off by pressing the on / off button for about 3 seconds.

The LED display on the adapter can indicate the following statuses:

- The green LED lights constantly: The adapter is switched on and is ready for operation.
- The red LED blinks rapidly: Battery charge state is low.
- The green LED blinks: The adapter has just been switched on.
- The green LED blinks: Data transfer in progress.
- The red LED blinks and the adapter switches itself off: Memory is 95% full.

7.4 Data transfer

7.4.1 Transferring data from the scanner to the monitor

NOTE

Ensure that the correct project is selected on the monitor before transferring data.

NOTE

Check that the windows over the infrared ports are free from dirt, dust and grease and are not excessively scratched before commencing data transfer. Failure to do so may result in reduced data transfer range or may prevent data transfer.

Data is transferred from the scanner to the monitor using the infrared connection. The infrared windows are situated at the ends of scanner and the monitor.

Data can be transferred at any time when the scanner and monitor are switched on, the PS 200 S scanner is displaying the main menu and data transfer by infrared is activated on the monitor.

The project into which the data is to be copied is selected on the monitor under Projects.

Then select Import and confirm "From PS 200 S" by pressing the OK button. The infrared symbol then appears in the status area of the PSA 100 monitor.

Bring the scanner and monitor close together so that the infrared windows are facing each other. The two devices recognize each other automatically and establish communication.

This screen appears on the scanner and a beep sounds:

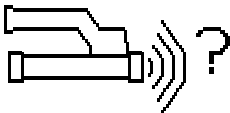

Press the Confirm button on the scanner to begin importing all scan data into the selected project.

This screen appears on the scanner while data transfer is in progress and the red LED on the scanner blinks continuously.

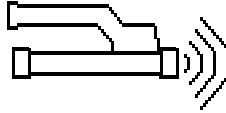

Data transfer takes between 1 and 15 seconds, depending on the number and length of scans contained in the scanner.

This screen is displayed by the scanner when data transfer is complete:

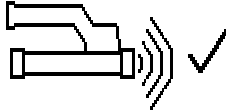

Press the Confirm button on the scanner again to end the data transfer procedure.

The scan data in the scanner is then deleted automatically.

7.4.2 Transferring data from the scanner to the adapter

DANGER

Use the adapter only indoors. Avoid moisture ingress.

NOTE

Check that the windows over the infrared ports are free from dirt, dust and grease and are not excessively scratched before commencing data transfer. Failure to do so may result in reduced data transfer range or may prevent data transfer.

Data is transferred from the scanner to the adapter using the infrared connection. The infrared windows are situated at the ends of scanner and the adapter.

NOTE

The maximum range of the infrared connection is approximately 30 cm. The maximum permissible angle between the scanner and adapter for successful data transmission at close ranges (up to 10 cm) is $\pm 50^\circ$ relative to the axis of the infrared port on the adapter. At a distance of 15 cm this angle is reduced to $\pm 30^\circ$. At a distance of 30 cm the scanner must be accurately aligned with the adapter to ensure successful data transmission. Scans can be transferred at any time when the scanner and adapter are switched on and the scanner is displaying the main menu.

Bring the scanner and adapter close together so that the infrared windows are facing each other. The two devices recognize each other automatically and establish communication.

The following screen appears on the scanner and a beep sounds:

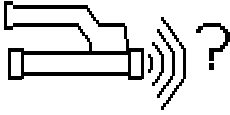

en

Press the Confirm button on the scanner to begin data transfer. The following may be observed while data transfer is in progress:

The green LED on the adapter blinks rapidly to indicate that data transfer is in progress. The red LED on the scanner blinks continuously:

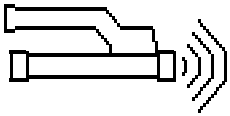

Data transfer takes between 1 and 15 seconds, depending on the number and length of scans contained in the scanner. The LED on the adapter lights green again when data transfer is finished.

This screen is displayed by the scanner when data transfer is complete:

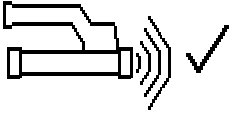

All scan data has then been successfully transferred. Press the Confirm button on the scanner again to end the data transfer procedure. The scan data has been successfully transferred.

The scans are numbered by the adapter.

7.4.3 Transferring data from the adapter to the computer

NOTE

To ensure data security, data integrity and to avoid malfunctions, use only the PUA 95 Micro USB cable supplied by Hilti.

The PUA 95 Micro USB data cable is used to transfer data from the adapter to the computer.

The adapter can be removed once data transfer is complete.

NOTE

In order to remove the PSA 55 adapter safely, we recommend use of the "Remove hardware safely" function of the operating system. This helps prevent loss of data integrity.

7.4.4 Transferring data from the monitor to the computer

NOTE

To ensure data security, data integrity and to avoid malfunctions, use only the PSA 92 Micro USB cable supplied by Hilti.

The PSA 92 USB data cable is used to transfer data from the monitor to the computer.

7.5 Tips for scanning and evaluation

The object is too narrow to scan or reinforcement is too close to an outside edge to be scanned properly.

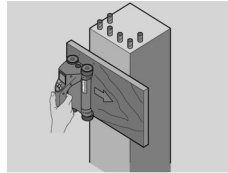

Use a thin sheet of non-metallic material (e.g. cardboard, wood, polystyrene foam,...) as an overlay that extends beyond the edge. The scanner can then be moved over the sheet to beyond the edge of the structure. Note that the thickness of the board must be deducted from any depth measurements. The thickness of the board can be entered in the PC application. This value will then be automatically deducted from any depth measurements.

The surface is rough.

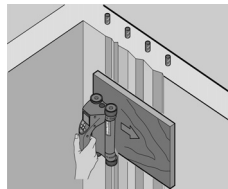

Rough surfaces (e.g. concrete surfaces with exposed aggregates) cause additional noise in the signal and may mean that the depth or diameter of a bar cannot be determined. In such cases it is also advantageous to scan through a thin overlay board. Also in this case, the thickness of the board must be deducted from any depth measurements.

Interference in images

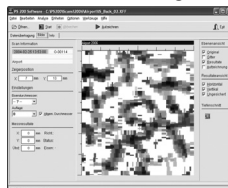

Interference in images may occur due to:

- Scraps of reinforcement in the concrete
- Tie wires where rebars cross
- Aggregates with ferromagnetic properties
- Ends of bars lying parallel to the scanning plane
- Ends of bars lying at right angles to the scanning plane (standing bars)

NOTE

Diameters and depths calculated in the area where interference occurs must be treated with caution as they may be inaccurate.

Scanning columns and beams for making penetrations

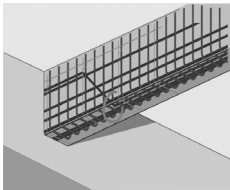

In cases where the reinforcement must not be damaged, ensure that Imagescans are made on at least three sides of the component in order to ensure that shear bars (placed at an angle in the concrete) can also be detected.

Simple diameter check

A simple, rough check of the diameter of the bars in the first layer can be made by deducting the depth of the second perpendicular layer from that of the first. This assumes however that the two layers touch each other or are at least very close.

7.6 PC software

The Hilti PROFIS Ferroskan PC application provides functions for enhanced analysis, easy creation of reports, data archival, image and data export to other PC applications as well as automated batch processing of large volumes of data.

The Hilti PROFIS Ferroskan MAP application makes it possible to merge large volumes of data, allowing the creation and evaluation of large-area images covering areas of up to 45 x 45 m.

Installation instructions can be found on the Hilti PROFIS Ferroskan software CD-ROM. Detailed information about using the PC application can be found in the Help menu.

8 Care and maintenance

8.1 Cleaning and drying

CAUTION

Do not use liquids other than alcohol or water. Other liquids may damage plastic parts.

Clean the parts of the tool only with a clean, soft cloth. Moisten the cloth with pure alcohol or a little water if necessary.

8.2 Storage

Do not store the tool when it is wet.

Dry and clean the tool, its case and accessories before storing.

Remove the batteries before storing.

After storing for a long period of time, carry out a measurement check before use.

Observe the temperature limits when storing your equipment, especially in winter / summer if the equipment is kept inside a motor vehicle (-25°C to +60°C).

8.3 Transport

DANGER

Remove the battery before storing or transporting the tool.

Always use the original Hilti toolbox when transporting the tool.

8.4 Removing / replacing the scanner wheels

CAUTION

Do not overtighten the screw when refitting the wheel as this may result in damage to the wheel and axle. Replace only one wheel at a time.

The scanner wheels can be removed either for cleaning or replacement.

Use a 2.5 mm Allen wrench to loosen and remove the screw at the wheel axle.

Carefully pull the wheel off the axle while holding the opposite end of the axle or other wheel. If necessary, clean the casing and/or wheel carefully see 8.1 before refitting the wheel to the axle and reinserting and tightening the screw.

8.5 Hilti Calibration Service

We recommend that the tool is checked by the Hilti Calibration Service at regular intervals in order to verify its reliability in accordance with standards and legal requirements.





Use can be made of the Hilti Calibration Service at any time, but checking at least once a year is recommended. The Calibration Service provides confirmation that the tool is in conformance, on the day it is tested, with the specifications given in the operating instructions.





After checking, a calibration sticker applied to the tool and a calibration certificate provide written verification that the tool is operating in accordance with the manufacturer's specification.

Calibration certificates are always required by companies certified according to ISO 900x. Your local Hilti Center or representative will be pleased to provide further information.

9 Troubleshooting

en

Message displayed	Fault	Possible cause	Remedy
 <p>Symbol appears while using Quickscan detection mode.</p>	The scanner is not recording.	The maximum scanning speed of 0.5 m/s was exceeded.	Press the Confirm button and repeat the scan. Move the scanner over the surface more slowly.
 <p>Symbol appears while making a Quickscan recording.</p>	The scanner is not recording.	The maximum scanning speed of 0.5 m/s was exceeded.	Press the Confirm button. Repeat the scanning operation from the starting point or from the last point at which a marker was set. Move the scanner over the surface more slowly.
 <p>Symbol appears while making an Imagescan.</p>	The scanner is not recording.	The maximum scanning speed of 0.5 m/s was exceeded.	Press the Confirm button. Scan the row or column again. Move the scanner over the surface more slowly.
 <p>Symbol appears.</p>	The scanner is not recording.	This symbol may appear if the scanner is moved in the wrong direction when in Quickscan recording mode, i.e. you begin scanning, for example, from right to left but at some point during the Quickscan recording you move the scanner to the right.	Press the Confirm button and repeat the scan. Move the scanner in the correct direction. NOTE The warning does not appear immediately, only when moved 15 cm or more in the wrong direction.

Message displayed	Fault	Possible cause	Remedy
 <p>This symbol may appear on the scanner during data transfer between the scanner and monitor.</p>	<p>Data is not being transferred.</p>	<p>Data transfer was interrupted or a connection could not be established.</p>	<p>Check that the scanner and monitor are positioned within maximum range (30 cm) and that they are correctly aligned with each other. Make sure that the atmosphere is as dust-free as possible and that the infrared windows on both scanner and monitor are clean and not badly scratched. Badly scratched windows must be replaced by Hilti Service. Try to hold the monitor and scanner steady and in correct alignment with each other until data transfer is completed.</p>
 <p>This symbol may appear on the scanner during data transfer between the scanner and monitor.</p>	<p>Data is not being transferred.</p>	<p>Indicates that the scanner or monitor may be defective.</p>	<p>Remedy the problem by switching the units off and on or adjusting their alignment with each other. NOTE Data is not lost in the event of an interruption in data transfer. Data is deleted from the scanner only once all scan data has been correctly transferred and the Confirm button on the scanner is pressed. If the error message is still displayed the tool must be returned to a Hilti Service Center.</p>
 <p>This symbol may appear during the transfer of data between the PS 200 S scanner and the PSA 55 adapter.</p>	<p>Data is not being transferred.</p>	<p>Indicates that the scanner or adapter may be defective.</p>	<p>Remedy the problem by switching the unit off and on or adjusting its alignment.</p>
 <p>A stop symbol generally indicates a fatal error in the scanner.</p>	<p>One of these symbols may be displayed immediately after the scanner is switched on.</p>	<p>They indicate a possible electronic fault.</p>	<p>Switch the scanner off and then on again. If the error message reappears the tool must be returned to Hilti for repair.</p>
 <p>A stop symbol generally indicates a fatal error in the scanner.</p>			

Message displayed	Fault	Possible cause	Remedy
 <p>An exclamation mark indicates either an error caused by the operator or an error that can be solved by the operator.</p>	<p>This symbol may appear when trying to enter the Imagescan or Blockscan scanning mode, when trying to begin a new Imagescan within Blockscan scanning mode or when trying to start Quickscan recording.</p>	<p>This indicates that the memory allocated to the operation is full and that no more data can be stored.</p>	<p>In this situation, the data must either be transferred to the monitor or deleted from scanner memory.</p> <p>NOTE Deleting the contents of scanner memory may result in data loss. Data that has not been transferred to the monitor will be permanently deleted.</p>

Fault	Possible cause	Remedy
The scanner doesn't start.	The battery pack is not charged.	Change the battery.
	The contacts on the battery pack or in the scanner are dirty.	Clean the contacts.
	The battery pack is old or defective, or the maximum number of charging cycles has been exceeded.	Contact Hilti Service.
The scanner doesn't run freely.	The wheels are dirty or dusty.	Remove the wheels and casing and clean the parts.
	The drive belt or gear teeth are worn.	Contact Hilti Service.
The scanner operates only for a short time before the battery pack is exhausted.	The battery pack is old or defective, or the maximum number of charging cycles has been exceeded.	Contact Hilti Service.
The scan date and time are not correct.	The Hilti PROFIS Ferrosan application was not used to set the date.	Install Hilti PROFIS Ferrosan V 5.7 (or a higher version) and start the application. Use the PSA 95 data cable to connect the adapter and then go to "Tools", "Workflow", "Set PSA 55 date and time" and set the current date and time.
The date and time cannot be set.	The date and time cannot be set as no device driver was found.	Install the driver manually: Use the PSA 95 data cable to connect the PSA 55 adapter to the computer. Install the device driver (Setup_PSA55.exe)

10 Disposal

WARNING

Improper disposal of the equipment may have serious consequences:

The burning of plastic components generates toxic fumes which may present a health hazard.

Batteries may explode if damaged or exposed to very high temperatures, causing poisoning, burns, acid burns or environmental pollution.

Careless disposal may permit unauthorized and improper use of the equipment. This may result in serious personal injury, injury to third parties and pollution of the environment.



Most of the materials from which Hilti tools or appliances are manufactured can be recycled. The materials must be correctly separated before they can be recycled. In many countries, Hilti has already made arrangements for taking back old tools or appliances for recycling. Ask Hilti Customer Service or your Hilti representative for further information.



Dispose of the batteries in accordance with national regulations. Please help us to protect the environment.

For EU countries only

Disposal of electrical appliances together with household waste is not permissible.

In observance of the European Directive on waste electrical and electronic equipment and its implementation in accordance with national law, electrical appliances and batteries that have reached the end of their life must be collected separately and returned to an environmentally compatible recycling facility.

en

11 Manufacturer's warranty

Please contact your local Hilti representative if you have questions about the warranty conditions.

12 EC declaration of conformity (original)

Designation:	Ferrosan system Ferrosan
Type:	PS 250 PS 200 S
Generation:	02
Year of design:	2012

We declare, on our sole responsibility, that this product complies with the following directives and standards: until 19th April 2016: 2004/108/EC, from 20th April 2016: 2014/30/EU, 2011/65/EU, 2006/66/EC, EN ISO 12100.

**Hilti Corporation, Feldkircherstrasse 100,
FL-9494 Schaan**

Paolo Luccini
Head of BA Quality and Process Management
Business Area Electric Tools & Accessories
06/2015

Edward Przybylowicz
Head of BU Measuring Systems
BU Measuring Systems
06/2015

Technical documentation filed at:

Hilti Entwicklungsgesellschaft mbH
Zulassung Elektrowerkzeuge
Hiltistrasse 6
86916 Kaufering
Deutschland

ANNEX

1.

DIN 488

Ø [mm]	↓ [mm]								
	20	40	60	80	100	120	140	160	180
6	±2	±3	±3	±4	±5	0	X	X	X
8	±2	±2	±3	±4	±5	0	0	X	X
10	±2	±2	±3	±4	±5	0	0	X	X
12	±2	±2	±3	±4	±5	±10	0	X	X
14	±2	±2	±3	±4	±5	±10	0	0	X
16	±2	±2	±3	±4	±5	±10	±12	0	X
20	±2	±2	±3	±4	±5	±10	±12	0	X
25	±2	±2	±3	±4	±5	±10	±12	0	X
28	±2	±2	±3	±4	±5	±10	±12	0	X
30	±2	±2	±3	±4	±5	±10	±12	0	X
36	±2	±2	±3	±4	±5	±10	±12	±13	X

ASTM

Ø	↓ [mm]								
	20	40	60	80	100	120	140	160	180
#3	±2	±2	±3	±4	±5	0	0	X	X
#4	±2	±2	±3	±4	±5	±10	0	X	X
#5	±2	±2	±3	±4	±5	±10	±12	0	X
#6	±2	±2	±3	±4	±5	±10	±12	0	X
#7	±2	±2	±3	±4	±5	±10	±12	0	X
#8	±2	±2	±3	±4	±5	±10	±12	0	X
#9	±2	±2	±3	±4	±5	±10	±12	0	X
#10	±2	±2	±3	±4	±5	±10	±12	0	X
#11	±2	±2	±3	±4	±5	±10	±12	±13	X

CAN

Ø	↓ [mm]								
	20	40	60	80	100	120	140	160	180
C10	±2	±2	±3	±4	±5	0	0	X	X
C15	±2	±2	±3	±4	±5	±10	±12	0	X
C20	±2	±2	±3	±4	±5	±10	±12	0	X
C25	±2	±2	±3	±4	±5	±10	±12	0	X
C30	±2	±2	±3	±4	±5	±10	±12	0	X
C35	±2	±2	±3	±4	±5	±10	±12	±13	0

JIS

Ø	↓ [mm]								
	20	40	60	80	100	120	140	160	180
D6	±2	±3	±3	±4	±5	0	X	X	X
D10	±2	±2	±3	±4	±5	0	0	X	X
D13	±2	±2	±3	±4	±5	±10	0	X	X

∅	↓ [mm]								
	20	40	60	80	100	120	140	160	180
D16	±2	±2	±3	±4	±5	±10	±12	0	X
D19	±2	±2	±3	±4	±5	±10	±12	0	X
D22	±2	±2	±3	±4	±5	±10	±12	0	X
D25	±2	±2	±3	±4	±5	±10	±12	0	X
D29	±2	±2	±3	±4	±5	±10	±12	0	X
D32	±2	±2	±3	±4	±5	±10	±12	0	X
D35	±2	±2	±3	±4	±5	±10	±12	±13	0
D38	±2	±2	±3	±4	±5	±10	±12	±13	0

GB 50010-2002

∅ [mm]	↓ [mm]								
	20	40	60	80	100	120	140	160	180
8	±2	±3	±3	±4	±5	0	X	X	X
10	±2	±2	±3	±4	±5	0	0	X	X
12	±2	±2	±3	±4	±5	±10	0	X	X
14	±2	±2	±3	±4	±5	±10	±12	0	X
16	±2	±2	±3	±4	±5	±10	±12	0	X
18	±2	±2	±3	±4	±5	±10	±12	0	X
20	±2	±2	±3	±4	±5	±10	±12	0	X
22	±2	±2	±3	±4	±5	±10	±12	0	X
25	±2	±2	±3	±4	±5	±10	±12	0	X
28	±2	±2	±3	±4	±5	±10	±12	±13	0
32	±2	±2	±3	±4	±5	±10	±12	±13	0
36	±2	±2	±3	±4	±5	±10	±12	±13	0

GOST 5781-82

∅ [mm]	↓ [mm]								
	20	40	60	80	100	120	140	160	180
8	±2	±3	±3	±4	±5	0	X	X	X
10	±2	±2	±3	±4	±5	0	0	X	X
12	±2	±2	±3	±4	±5	±10	0	X	X
14	±2	±2	±3	±4	±5	±10	±12	0	X
16	±2	±2	±3	±4	±5	±10	±12	0	X
18	±2	±2	±3	±4	±5	±10	±12	0	X
20	±2	±2	±3	±4	±5	±10	±12	0	X
22	±2	±2	±3	±4	±5	±10	±12	0	X
25	±2	±2	±3	±4	±5	±10	±12	0	X
28	±2	±2	±3	±4	±5	±10	±12	±13	0
32	±2	±2	±3	±4	±5	±10	±12	±13	0
36	±2	±2	±3	±4	±5	±10	±12	±13	0

BIS 1786:1985

∅ [mm]	↓ [mm]								
	20	40	60	80	100	120	140	160	180
6	±2	±3	±3	±4	±5	0	X	X	X
8	±2	±2	±3	±4	±5	0	0	X	X

Ø [mm]	↓ [mm]								
	20	40	60	80	100	120	140	160	180
10	±2	±2	±3	±4	±5	0	0	X	X
12	±2	±2	±3	±4	±5	0	0	X	X
16	±2	±2	±3	±4	±5	±10	±12	0	X
20	±2	±2	±3	±4	±5	±10	±12	0	X
25	±2	±2	±3	±4	±5	±10	±12	0	X
28	±2	±2	±3	±4	±5	±10	±12	0	X
32	±2	±2	±3	±4	±5	±10	±12	0	X

2.

DIN 488

Ø [mm]	↓ [mm]								
	20	40	60	80	100	120	140	160	180
6	±3	±3	±4	±6	±8	0	X	X	X
8	±3	±3	±4	±6	±8	0	0	X	X
10	±3	±3	±4	±6	±8	0	0	X	X
12	±3	±3	±4	±6	±8	±12	0	X	X
14	±3	±3	±4	±6	±8	±12	0	0	X
16	±3	±3	±4	±6	±8	±12	±14	0	X
20	±3	±3	±4	±6	±8	±12	±14	0	X
25	±3	±3	±4	±6	±8	±12	±14	0	X
28	±3	±3	±4	±6	±8	±12	±14	0	X
30	±3	±3	±4	±6	±8	±12	±14	0	X
36	±3	±3	±4	±6	±8	±12	±14	±16	X

ASTM

Ø	↓ [mm]								
	20	40	60	80	100	120	140	160	180
#3	±3	±3	±4	±6	±8	0	0	X	X
#4	±3	±3	±4	±6	±8	±12	0	X	X
#5	±3	±3	±4	±6	±8	±12	±14	0	X
#6	±3	±3	±4	±6	±8	±12	±14	0	X
#7	±3	±3	±4	±6	±8	±12	±14	0	X
#8	±3	±3	±4	±6	±8	±12	±14	0	X
#9	±3	±3	±4	±6	±8	±12	±14	0	X
#10	±3	±3	±4	±6	±8	±12	±14	0	X
#11	±3	±3	±4	±6	±8	±12	±14	±16	X

CAN

Ø	↓ [mm]								
	20	40	60	80	100	120	140	160	180
C10	±3	±3	±4	±6	±8	0	0	X	X
C15	±3	±3	±4	±6	±8	±12	±14	0	X
C20	±3	±3	±4	±6	±8	±12	±14	0	X
C25	±3	±3	±4	±6	±8	±12	±14	0	X

∅	↓ [mm]								
	20	40	60	80	100	120	140	160	180
C30	±3	±3	±4	±6	±8	±12	±14	0	X
C35	±3	±3	±4	±6	±8	±12	±14	±16	X

JIS

∅	↓ [mm]								
	20	40	60	80	100	120	140	160	180
D6	±3	±3	±4	±6	±8	0	X	X	X
D10	±3	±3	±4	±6	±8	0	0	X	X
D13	±3	±3	±4	±6	±8	±12	0	X	X
D16	±3	±3	±4	±6	±8	±12	±14	0	X
D19	±3	±3	±4	±6	±8	±12	±14	0	X
D22	±3	±3	±4	±6	±8	±12	±14	0	X
D25	±3	±3	±4	±6	±8	±12	±14	0	X
D29	±3	±3	±4	±6	±8	±12	±14	0	X
D32	±3	±3	±4	±6	±8	±12	±14	0	X
D35	±3	±3	±4	±6	±8	±12	±14	±16	X
D38	±3	±3	±4	±6	±8	±12	±14	±16	X

GB 50010-2002

∅ [mm]	↓ [mm]								
	20	40	60	80	100	120	140	160	180
8	±3	±3	±4	±6	±8	0	X	X	X
10	±3	±3	±4	±6	±8	0	0	X	X
12	±3	±3	±4	±6	±8	±12	0	X	X
14	±3	±3	±4	±6	±8	±12	±14	0	X
16	±3	±3	±4	±6	±8	±12	±14	0	X
18	±3	±3	±4	±6	±8	±12	±14	0	X
20	±3	±3	±4	±6	±8	±12	±14	0	X
22	±3	±3	±4	±6	±8	±12	±14	0	X
25	±3	±3	±4	±6	±8	±12	±14	0	X
28	±3	±3	±4	±6	±8	±12	±14	±16	X
32	±3	±3	±4	±6	±8	±12	±14	±16	X
36	±3	±3	±4	±6	±8	±12	±14	±16	X

GOST 5781-82

∅ [mm]	↓ [mm]								
	20	40	60	80	100	120	140	160	180
8	±3	±3	±4	±6	±8	0	X	X	X
10	±3	±3	±4	±6	±8	0	0	X	X
12	±3	±3	±4	±6	±8	±12	0	X	X
14	±3	±3	±4	±6	±8	±12	±14	0	X
16	±3	±3	±4	±6	±8	±12	±14	0	X
18	±3	±3	±4	±6	±8	±12	±14	0	X
20	±3	±3	±4	±6	±8	±12	±14	0	X
22	±3	±3	±4	±6	±8	±12	±14	0	X
25	±3	±3	±4	±6	±8	±12	±14	0	X
28	±3	±3	±4	±6	±8	±12	±14	±16	X

Ø [mm]	↓ [mm]								
	20	40	60	80	100	120	140	160	180
32	±3	±3	±4	±6	±8	±12	±14	±16	X
36	±3	±3	±4	±6	±8	±12	±14	±16	X

BIS 1786:1985

Ø [mm]	↓ [mm]								
	20	40	60	80	100	120	140	160	180
6	±3	±3	±4	±6	±8	0	X	X	X
8	±3	±3	±4	±6	±8	0	0	X	X
10	±3	±3	±4	±6	±8	0	0	X	X
12	±3	±3	±4	±6	±8	±12	0	X	X
16	±3	±3	±4	±6	±8	±12	0	0	X
20	±3	±3	±4	±6	±8	±12	±14	0	X
25	±3	±3	±4	±6	±8	±12	±14	0	X
28	±3	±3	±4	±6	±8	±12	±14	0	X
32	±3	±3	±4	±6	±8	±12	±14	0	X

3.

DIN 488

Ø [mm]	↓ [mm]					
	20	40	50	60	80	100
6	±1	±1	±2	±2	±4	±5
8	±1	±1	±2	±2	±4	±5
10	±1	±1	±2	±2	±4	±5
12	±1	±1	±2	±2	±4	±5
14	±1	±1	±2	±2	±4	±5
16	±1	±1	±2	±2	±4	±5
20	±1	±1	±2	±2	±4	±5
25	±1	±1	±2	±2	±4	±5
28	±1	±1	±2	±2	±4	±6
30	±1	±1	±2	±2	±4	±5
36	±1	±1	±2	±2	±4	±5

ASTM

Ø	↓ [mm]					
	20	40	50	60	80	100
#3	±1	±1	±2	±2	±4	±5
#4	±1	±1	±2	±2	±4	±5
#5	±1	±1	±2	±2	±4	±5
#6	±1	±1	±2	±2	±4	±5
#7	±1	±1	±2	±2	±4	±5
#8	±1	±1	±2	±2	±4	±5
#9	±1	±1	±2	±2	±4	±5
#10	±1	±1	±2	±2	±4	±5
#11	±1	±1	±2	±2	±4	±6

CAN

Ø	↓ [mm]					
	20	40	50	60	80	100
C10	±1	±1	±2	±2	±4	±5
C15	±1	±1	±2	±2	±4	±5
C20	±1	±1	±2	±2	±4	±5
C25	±1	±1	±2	±2	±4	±5
C30	±1	±1	±2	±2	±4	±5
C35	±1	±1	±2	±2	±4	±5

JIS

Ø	↓ [mm]					
	20	40	50	60	80	100
D6	±1	±1	±2	±2	±4	±5
D10	±1	±1	±2	±2	±4	±5
D13	±1	±1	±2	±2	±4	±5
D16	±1	±1	±2	±2	±4	±5
D19	±1	±1	±2	±2	±4	±5
D22	±1	±1	±2	±2	±4	±5
D25	±1	±1	±2	±2	±4	±5
D29	±1	±1	±2	±2	±4	±5
D32	±1	±1	±2	±2	±4	±6
D35	±1	±1	±2	±2	±4	±6
D38	±1	±1	±2	±2	±4	±6

GB 50010-2002

Ø [mm]	↓ [mm]					
	20	40	50	60	80	100
8	±1	±1	±2	±2	±4	±5
10	±1	±1	±2	±2	±4	±5
12	±1	±1	±2	±2	±4	±5
14	±1	±1	±2	±2	±4	±5
16	±1	±1	±2	±2	±4	±5
18	±1	±1	±2	±2	±4	±5
20	±1	±1	±2	±2	±4	±5
22	±1	±1	±2	±2	±4	±5
25	±1	±1	±2	±2	±4	±6
28	±1	±1	±2	±2	±4	±6
32	±1	±1	±2	±2	±4	±6
36	±1	±1	±2	±2	±4	±6

GOST 5781-82

Ø [mm]	↓ [mm]					
	20	40	50	60	80	100
8	±1	±1	±2	±2	±4	±5
10	±1	±1	±2	±2	±4	±5
12	±1	±1	±2	±2	±4	±5

Ø [mm]	↓ [mm]					
	20	40	50	60	80	100
14	±1	±1	±2	±2	±4	±5
16	±1	±1	±2	±2	±4	±5
18	±1	±1	±2	±2	±4	±5
20	±1	±1	±2	±2	±4	±5
22	±1	±1	±2	±2	±4	±5
25	±1	±1	±2	±2	±4	±5
28	±1	±1	±2	±2	±4	±5
32	±1	±1	±2	±2	±4	±5
36	±1	±1	±2	±2	±4	±5

BIS 1786:1985

Ø [mm]	↓ [mm]					
	20	40	50	60	80	100
6	±1	±1	±2	±2	±4	±5
8	±1	±1	±2	±2	±4	±5
10	±1	±1	±2	±2	±4	±5
12	±1	±1	±2	±2	±4	±5
16	±1	±1	±2	±2	±4	±5
20	±1	±1	±2	±2	±4	±5
25	±1	±1	±2	±2	±4	±5
28	±1	±1	±2	±2	±4	±5
32	±1	±1	±2	±2	±4	±5

4.

DIN 488

Ø [mm]	↓ [mm]					
	20	40	50	60	80	100
6	±2	±2	±2	±3	±4	±5
8	±2	±2	±2	±3	±4	±5
10	±2	±2	±2	±3	±4	±5
12	±2	±2	±2	±3	±4	±5
14	±2	±2	±2	±3	±4	±5
16	±2	±2	±2	±3	±4	±5
20	±2	±2	±2	±3	±4	±5
25	±2	±2	±2	±3	±4	±5
28	±2	±2	±2	±3	±4	±5
30	±2	±2	±2	±3	±4	±5
36	±2	±2	±2	±3	±4	±5

ASTM

Ø	↓ [mm]					
	20	40	50	60	80	100
#3	±2	±2	±2	±3	±4	±5
#4	±2	±2	±2	±3	±4	±5

Ø	↓ [mm]					
	20	40	50	60	80	100
#5	±2	±2	±2	±3	±4	±5
#6	±2	±2	±2	±3	±4	±5
#7	±2	±2	±2	±3	±4	±5
#8	±2	±2	±2	±3	±4	±5
#9	±2	±2	±2	±3	±4	±5
#10	±2	±2	±2	±3	±4	±5
#11	±2	±2	±2	±3	±4	±5

CAN

Ø	↓ [mm]					
	20	40	50	60	80	100
C10	±2	±2	±2	±3	±4	±5
C15	±2	±2	±2	±3	±4	±5
C20	±2	±2	±2	±3	±4	±5
C25	±2	±2	±2	±3	±4	±5
C30	±2	±2	±2	±3	±4	±5
C35	±2	±2	±2	±3	±4	±5

JIS

Ø	↓ [mm]					
	20	40	50	60	80	100
D6	±2	±2	±2	±3	±4	±5
D10	±2	±2	±2	±3	±4	±5
D13	±2	±2	±2	±3	±4	±5
D16	±2	±2	±2	±3	±4	±5
D19	±2	±2	±2	±3	±4	±5
D22	±2	±2	±2	±3	±4	±5
D25	±2	±2	±2	±3	±4	±5
D29	±2	±2	±2	±3	±4	±5
D32	±2	±2	±2	±3	±4	±5
D35	±2	±2	±2	±3	±4	±5
D38	±2	±2	±2	±3	±4	±5

GB 50010-2002

Ø	↓ [mm]					
	20	40	50	60	80	100
8	±2	±2	±2	±3	±4	±5
10	±2	±2	±2	±3	±4	±5
12	±2	±2	±2	±3	±4	±5
14	±2	±2	±2	±3	±4	±5
16	±2	±2	±2	±3	±4	±5
18	±2	±2	±2	±3	±4	±5
20	±2	±2	±2	±3	±4	±5
22	±2	±2	±2	±3	±4	±5
25	±2	±2	±2	±3	±4	±5
28	±2	±2	±2	±3	±4	±5

∅	↓ [mm]					
	20	40	50	60	80	100
32	±2	±2	±2	±3	±4	±5
36	±2	±2	±2	±3	±4	±5

GOST 5781-82

∅ [mm]	↓ [mm]					
	20	40	50	60	80	100
8	±2	±2	±2	±3	±4	±5
10	±2	±2	±2	±3	±4	±5
12	±2	±2	±2	±3	±4	±5
14	±2	±2	±2	±3	±4	±5
16	±2	±2	±2	±3	±4	±5
18	±2	±2	±2	±3	±4	±5
20	±2	±2	±2	±3	±4	±5
22	±2	±2	±2	±3	±4	±5
25	±2	±2	±2	±3	±4	±5
28	±2	±2	±2	±3	±4	±5
32	±2	±2	±2	±3	±4	±5
36	±2	±2	±2	±3	±4	±5

BIS 1786:1985

∅ [mm]	↓ [mm]					
	20	40	50	60	80	100
6	±2	±2	±2	±3	±4	±5
8	±2	±2	±2	±3	±4	±5
10	±2	±2	±2	±3	±4	±5
12	±2	±2	±2	±3	±4	±5
16	±2	±2	±2	±3	±4	±5
20	±2	±2	±2	±3	±4	±5
25	±2	±2	±2	±3	±4	±5
28	±2	±2	±2	±3	±4	±5
32	±2	±2	±2	±3	±4	±5



Hilti Corporation

LI-9494 Schaan

Tel.: +423/234 21 11

Fax: +423/234 29 65

www.hilti.com

Hilti = registered trademark of Hilti Corp., Schaan
Pos. 1 | 20150929



2037330