

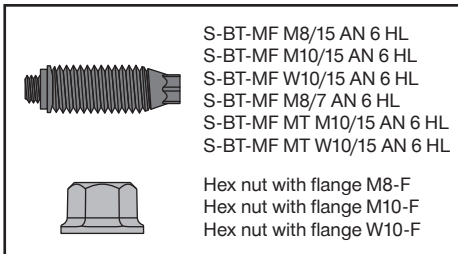

S-BT-MF M8/M10/W10 AN 6 HL
S-BT-MF MT M10/15 AN 6 HL

2353549-03.2023

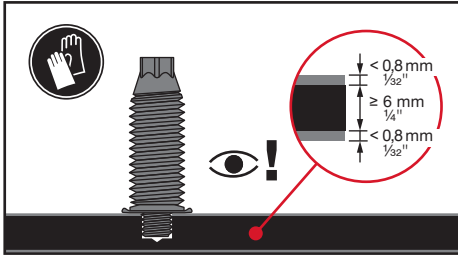

	SBT 4	SBT 6 SF 6
	TS-BT 5.3-65 S	
	S-DG BT M8/15 Long 6 S-DG BT M10/W10/15 Long 6 S-DG BT M8/7 Short 6	
	Torque Tool S-BT 1/4" 16 Nm / 11.8 lb-ft	
	S-NS 13 C 95/3 1/4" (M8) S-NS 15 C 95/3 1/4" (M10) S-NS 9/16" C 95/3 1/4" (W10)	
	S-CC BT 6	

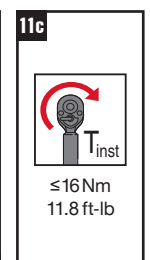
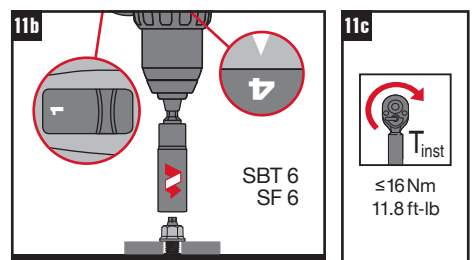
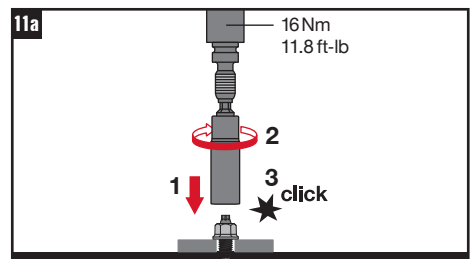
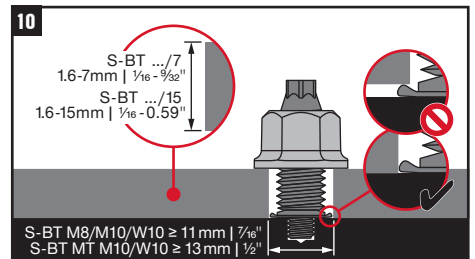
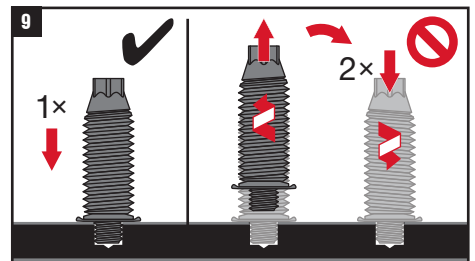
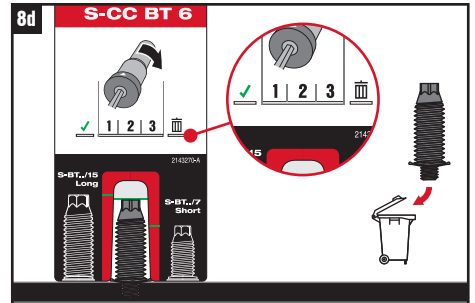
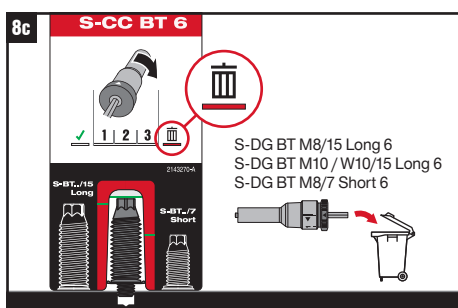
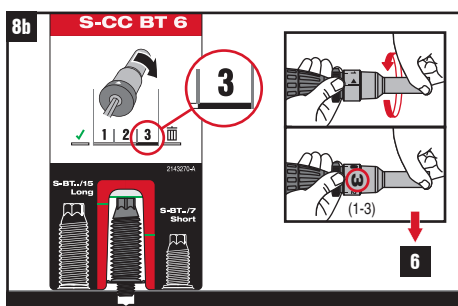
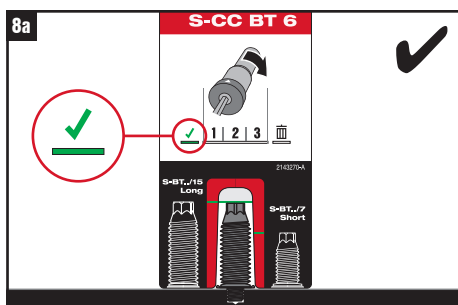
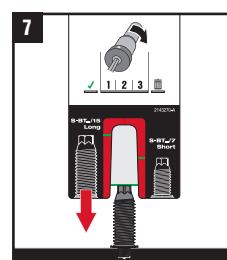
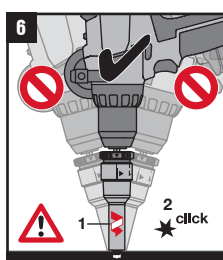
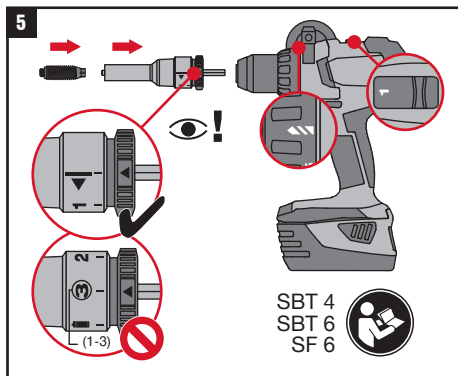
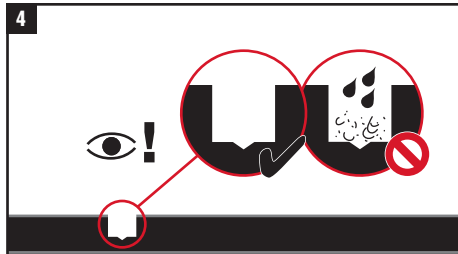
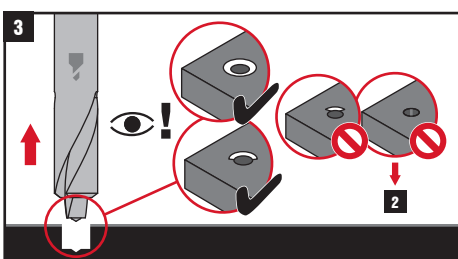
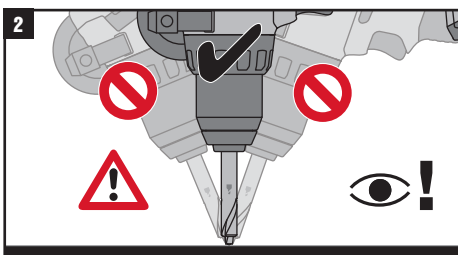
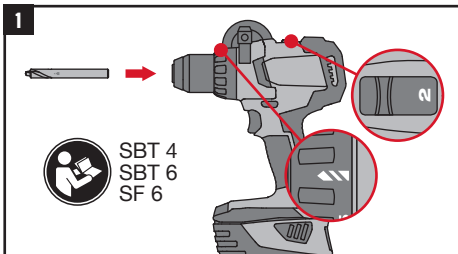

CE
23
Hilti Corporation, Feldkircherstrasse 100, FL-9494 Schaan, Liechtenstein
Hilti-SF-DoP-045
ETA-23/0001
EAD 333037-00-0602
0672-CPR
Threaded studs for connection of materials to structural steel and aluminium members
www.hilti.group



S-BT-MF M8/M10/W10 AN 6 HL
S-BT-MF MT M10/W10 AN 6 HL

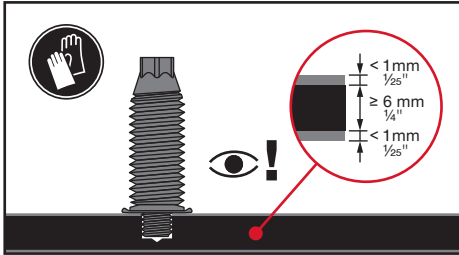

- S-BT-MF M8/15 AN 6 HL
 - S-BT-MF M10/15 AN 6 HL
 - S-BT-MF W10/15 AN 6 HL
 - S-BT-MF M8/7 AN 6 HL
 - S-BT-MF MT M10/15 AN 6 HL
 - S-BT-MF MT W10/15 AN 6 HL
- Hex nut with flange M8-F
Hex nut with flange M10-F
Hex nut with flange W10-F

	SBT 6
	TS-BT 5.3-65 S
	S-SH BT M8/M10/W10
	Torque Tool S-BT 1/4" 16 Nm / 11.8 lb-ft
	S-NS 13 C 95/3 1/4" (M8)
	S-NS 15 C 95/3 1/4" (M10)
	S-NS 9/16" C 95/3 1/4" (W10)
	S-IC BT

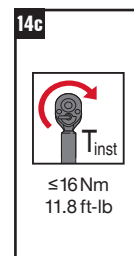
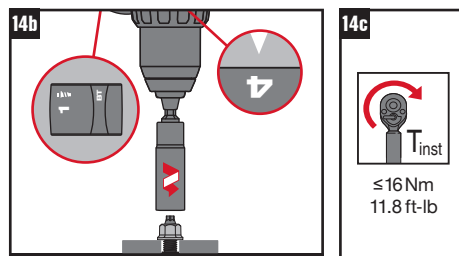
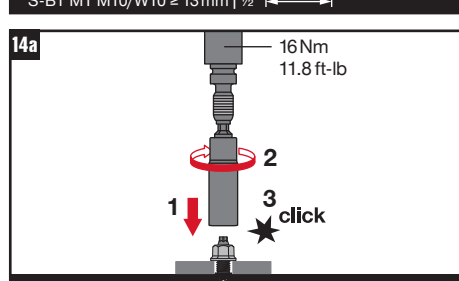
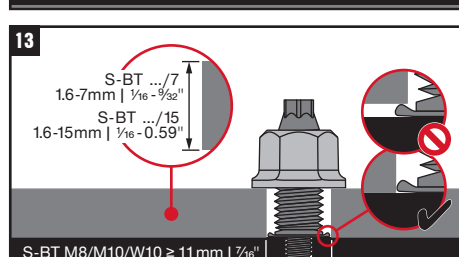
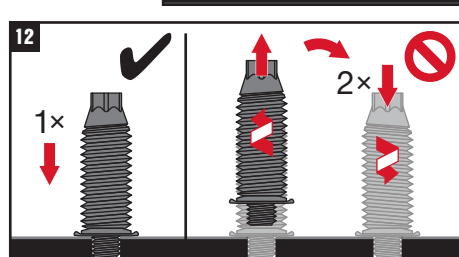
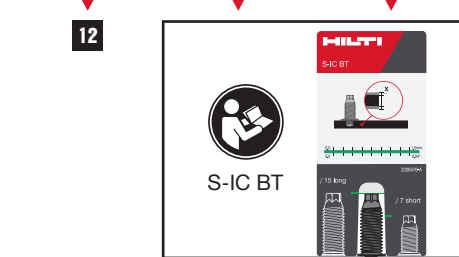
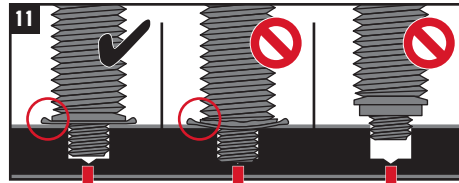
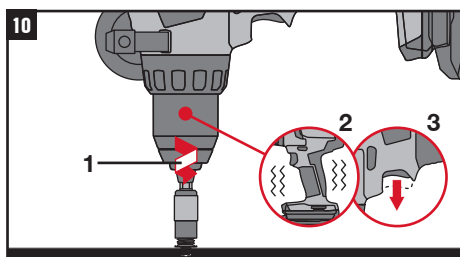
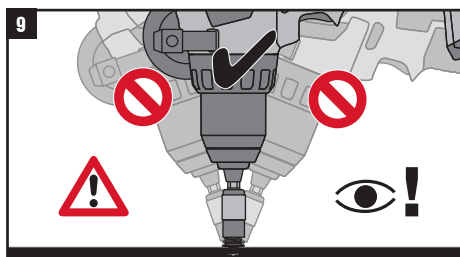
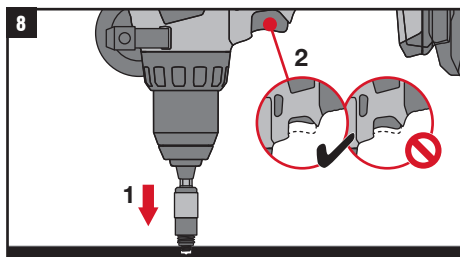
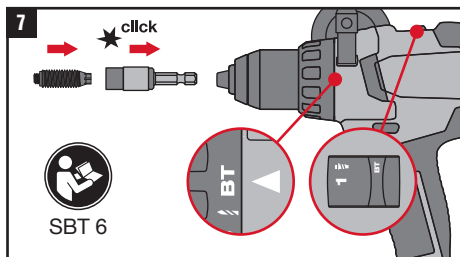
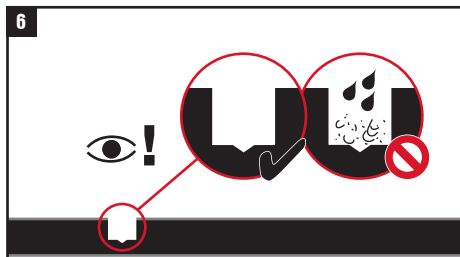
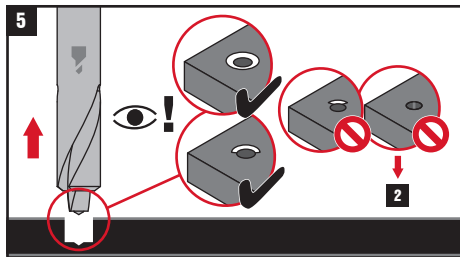
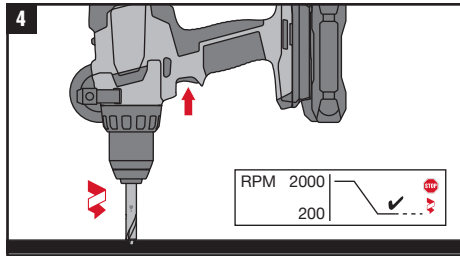
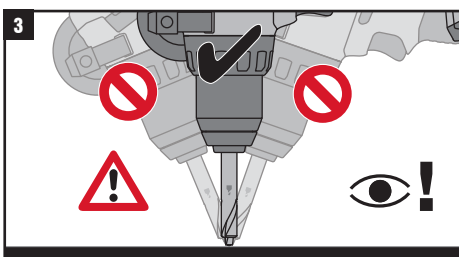
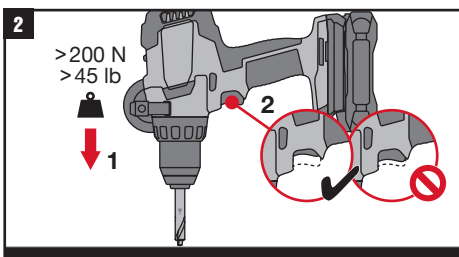
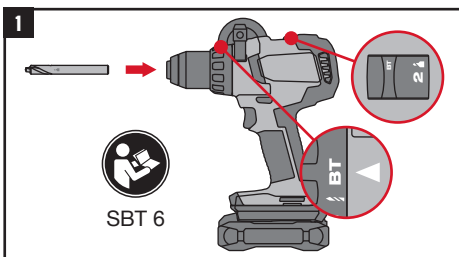

CE
23
Hilti Corporation, Feldkircherstrasse 100, FL-9494 Schaan, Liechtenstein
Hilti-SF-DoP-045
ETA-23/0001
EAD 333037-00-0602
0672-CPR
Threaded studs for connection of materials to structural steel and aluminium members
www.hilti.group